

USER'S MANUAL

notebook



Notice

The company reserves the right to revise this publication or to change its contents without notice. Information contained herein is for reference only and does not constitute a commitment on the part of the manufacturer or any subsequent vendor. They assume no responsibility or liability for any errors or inaccuracies that may appear in this publication nor are they in anyway responsible for any loss or damage resulting from the use (or misuse) of this publication.

This publication and any accompanying software may not, in whole or in part, be reproduced, translated, transmitted or reduced to any machine readable form without prior consent from the vendor, manufacturer or creators of this publication, except for copies kept by the user for backup purposes.

Brand and product names mentioned in this publication may or may not be copyrights and/or registered trademarks of their respective companies. They are mentioned for identification purposes only and are not intended as an endorsement of that product or its manufacturer.

©April 2020

Trademarks

Intel, **Pentium** and **Intel Celeron** are trademarks/registered trademarks of Intel Corporation.



Preface

R&TTE Directive

This device is in compliance with the essential requirements and other relevant provisions of the R&TTE Directive 1999/5/EC.

This device will be sold in the following EEA countries: Austria, Italy, Belgium, Liechtenstein, Denmark, Luxembourg, Finland, Netherlands, France, Norway, Germany, Portugal, Greece, Spain, Iceland, Sweden, Ireland, United Kingdom, Cyprus, Czech Republic, Estonia, Hungary, Latvia, Lithuania, Malta, Slovakia, Poland, Slovenia.

ErP Off Mode Power Consumption Statement:

The figures below note the power consumption of this computer in compliance with European Commission (EC) regulations on power consumption in off mode:

- Off Mode < 0.5W

CE Marking

This device has been tested to and conforms to the regulatory requirements of the European Union and has attained CE Marking. The CE Mark is a conformity marking consisting of the letters “CE”. The CE Mark applies to products regulated by certain European health, safety and environmental protection legislation. The CE Mark is obligatory for products it applies to: the manufacturer affixes the marking in order to be allowed to sell his product in the European market.

This product conforms to the essential requirements of the R&TTE directive 1999/5/EC in order to attain CE Marking. A notified body has determined that this device has properly demonstrated that the requirements of the directive have been met and has issued a favorable certificate of expert opinion. As such the device will bear the notified body number 0560 after the CE mark.

The CE Marking is not a quality mark. Foremost, it refers to the safety rather than to the quality of a product. Secondly, CE Marking is mandatory for the product it applies to, whereas most quality markings are voluntary.

FCC Statement (Federal Communications Commission)

You are cautioned that changes or modifications not expressly approved by the party responsible for compliance could void the user's authority to operate the equipment.

This equipment has been tested and found to comply with the limits for a Class B digital device, pursuant to Part 15 of the FCC Rules. These limits are designed to provide reasonable protection against harmful interference in a residential installation. This equipment generates, uses and can radiate radio frequency energy and, if not installed and used in accordance with the instructions, may cause harmful interference to radio communications. However, there is no guarantee that interference will not occur in a particular installation. If this equipment does cause harmful interference to radio or television reception, which can be determined by turning the equipment off and on, the user is encouraged to try to correct the interference by one or more of the following measures:

- Re orient or relocate the receiving antenna.
- Increase the separation between the equipment and receiver.
- Connect the equipment into an outlet on a circuit different from that to which the receiver is connected.
- Consult the service representative or an experienced radio/TV technician for help.

Operation is subject to the following two conditions:

1. This device may not cause interference.

And

2. This device must accept any interference, including interference that may cause undesired operation of the device.

FCC RF Radiation Exposure Statement:

1. This Transmitter must not be co-located or operating in conjunction with any other antenna or transmitter.
2. This equipment complies with FCC RF radiation exposure limits set forth for an uncontrolled environment. This equipment should be installed and operated with a minimum distance of 20 centimeters between the radiator and your body.



Warning

Use only shielded cables to connect I/O devices to this equipment. You are cautioned that changes or modifications not expressly approved by the manufacturer for compliance with the above standards could void your authority to operate the equipment.

IMPORTANT SAFETY INSTRUCTIONS

Follow basic safety precautions, including those listed below, to reduce the risk of fire, electric shock, and injury to persons when using any electrical equipment:

1. Do not use this product near water, for example near a bath tub, wash bowl, kitchen sink or laundry tub, in a wet basement or near a swimming pool.
2. Avoid using this equipment with a telephone line (other than a cordless type) during an electrical storm. There may be a remote risk of electrical shock from lightning.
3. Do not use the telephone to report a gas leak in the vicinity of the leak.
4. Use only the power cord and batteries indicated in this manual. Do not dispose of batteries in a fire. They may explode. Check with local codes for possible special disposal instructions.
5. This product is intended to be supplied by a Listed Power Unit according to the model's requirements:
 - Full Range AC/DC Adapter - AC Input 100 - 240V, 50 - 60Hz, DC Output 19.5V, 9.23A (**180 Watts**) minimum.

Instructions for Care and Operation

The notebook computer is quite rugged, but it can be damaged. To prevent this, follow these suggestions:

1. **Don't drop it, or expose it to shock.** If the computer falls, the case and the components could be damaged.



2. **Keep it dry, and don't overheat it.** Keep the computer and power supply away from any kind of heating element. This is an electrical appliance. If water or any other liquid gets into it, the computer could be badly damaged.

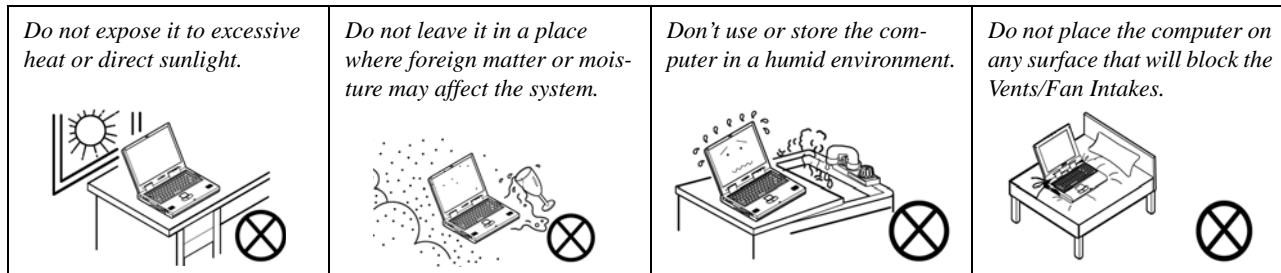

Preface

- Avoid interference.** Keep the computer away from high capacity transformers, electric motors, and other strong magnetic fields. These can hinder proper performance and damage your data.
- Follow the proper working procedures for the computer.** Shut the computer down properly and don't forget to save your work. Remember to periodically save your data as data may be lost if the battery is depleted.

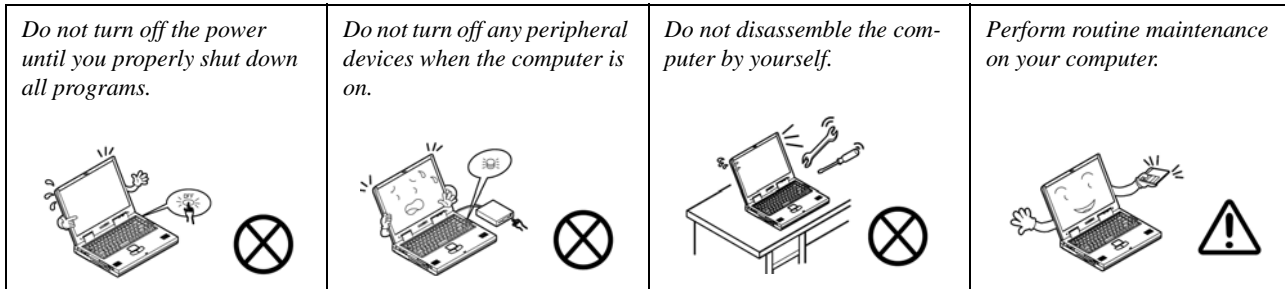

- Take care when using peripheral devices.**

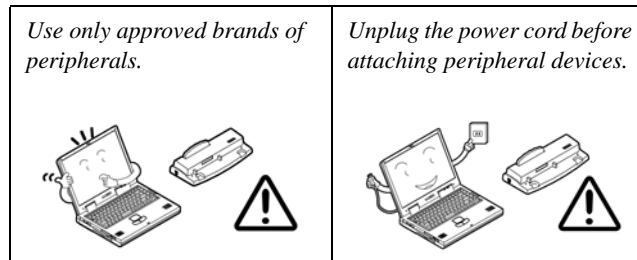

Servicing

Do not attempt to service the computer yourself. Doing so may violate your warranty and may expose you and the computer to electric shock. Refer all servicing to authorized service personnel. Unplug the computer from the power supply. Then refer servicing to qualified service personnel under any of the following conditions:

- When the power cord or AC/DC adapter is damaged or frayed.
- If the computer has been exposed to rain or other liquids.
- If the computer does not work normally when you follow the operating instructions.
- If the computer has been dropped or damaged (do not touch the poisonous liquid if the LCD panel breaks).
- If there is an unusual odor, heat or smoke coming from your computer.



Bottom Cover Removal Warning

Users should not remove any cover(s) and /or screw(s) for the purposes of device upgrade as this may violate the terms of your warranty. If you need to replace/remove the hard disk/RAM/optical device etc., for any reason, please contact your distributor/supplier for further information.

Removal Warning

When removing any cover(s) and screw(s) for the purposes of device upgrade, remember to replace the cover(s) and screw(s) before restoring power to the system.

Also note the following when the cover is removed:

- Hazardous moving parts.
- Keep away from moving fan blades.

Power Safety

The computer has specific power requirements:



Power Safety Warning

Before you undertake any upgrade procedures, make sure that you have turned off the power, and disconnected all peripherals and cables (including telephone lines and power cord).

You must also remove your battery in order to prevent accidentally turning the machine on. **Before removing the battery disconnect the AC/DC adapter from the computer.**

- Only use a power adapter approved for use with this computer.
- Your AC/DC adapter may be designed for international travel but it still requires a steady, uninterrupted power supply. If you are unsure of your local power specifications, consult your service representative or local power company.
- The power adapter may have either a 2-prong or a 3-prong grounded plug. The third prong is an important safety feature; do not defeat its purpose. If you do not have access to a compatible outlet, have a qualified electrician install one.
- When you want to unplug the power cord, be sure to disconnect it by the plug head, not by its wire.
- Make sure the socket and any extension cord(s) you use can support the total current load of all the connected devices.
- Before cleaning the computer, make sure it is disconnected from any external power supplies (i.e. AC/DC adapter or car adapter).

Do not plug in the power cord if you are wet.



Do not use the power cord if it is broken.

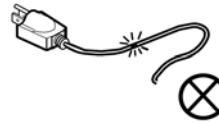

Do not place heavy objects on the power cord.

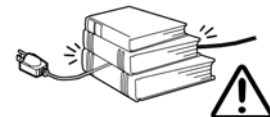

Polymer Battery Precautions

Note the following information which is specific to polymer batteries only, and where applicable, this overrides the general battery precaution information overleaf.

- Polymer batteries may experience a slight expansion or swelling, however this is part of the battery's safety mechanism and is not a cause for concern.
- Use proper handling procedures when using polymer batteries. Do not use polymer batteries in high ambient temperature environments, and do not store unused batteries for extended periods.
- If you are working in areas of low temperature use the AC/DC adapter to power the computer.

See also the general battery precautionary information overleaf for further information.

General Battery Precautions

- Only use batteries designed for this computer. The wrong battery type may explode, leak or damage the computer.
- Do not remove any batteries from the computer while it is powered on.
- Do not continue to use a battery that has been dropped, or that appears damaged (e.g. bent or twisted) in any way. Even if the computer continues to work with a damaged battery in place, it may cause circuit damage, which may possibly result in fire.
- If you do not use the battery for an extended period, then remove the battery from the computer for storage.
- Recharge the batteries using the notebook's system. Incorrect recharging may make the battery explode.
- Do not try to repair a battery pack. Refer any battery pack repair or replacement to your service representative or qualified service personnel.
- Keep children away from, and promptly dispose of a damaged battery. Always dispose of batteries carefully. Batteries may explode or leak if exposed to fire, or improperly handled or discarded.
- Keep the battery away from metal appliances.
- Affix tape to the battery contacts before disposing of the battery.
- Do not touch the battery contacts with your hands or metal objects.



Battery Disposal & Caution

The product that you have purchased contains a rechargeable battery. The battery is recyclable. At the end of its useful life, under various state and local laws, it may be illegal to dispose of this battery into the municipal waste stream. Check with your local solid waste officials for details in your area for recycling options or proper disposal.

Danger of explosion if battery is incorrectly replaced. Replace only with the same or equivalent type recommended by the manufacturer. Discard used battery according to the manufacturer's instructions.

Cleaning

Do not apply cleaner directly to the computer; use a soft clean cloth.

Do not use volatile (petroleum distillates) or abrasive cleaners on any part of the computer.

Cleaning Instructions

(For Computer Models Supplied with Light Blue Cleaning Cloth)

Some computer models in this series come supplied with a light blue cleaning cloth. To clean the computer case with this cloth follow the instructions below:

1. Power off the computer and peripherals.
2. Disconnect the AC/DC adapter from the computer.
3. Use a little water to dampen the cloth slightly.
4. Clean the computer case with the cloth.
5. Dry the computer with a dry cloth, or allow it time to dry before turning on.
6. Reconnect the AC/DC adapter and turn the computer on.

Travel Considerations

As you get ready for your trip, run through this list to make sure the system is ready to go:

1. Check that the battery pack and any spares are fully charged.
2. Power off the computer and peripherals.
3. Close the display panel and make sure it's latched.
4. Disconnect the AC/DC adapter and cables. Stow them in the carrying bag.
5. The AC/DC adapter uses voltages from 100 to 240 volts so you won't need a second voltage adapter. However, check with your travel agent to see if you need any socket adapters.
6. Put the notebook in its carrying bag and secure it with the bag's straps.
7. If you're taking any peripherals (e.g. a printer, mouse or digital camera), pack them and those devices' adapters and/or cables.
8. Anticipate customs - Some jurisdictions may have import restrictions or require proof of ownership for both hardware and software. Make sure your "papers" are handy.



Power Off Before Traveling

Make sure that your notebook is completely powered off before putting it into a travel bag (or any such container). Putting a notebook which is powered on in a travel bag may cause the Vents/Fan Intakes to be blocked. To prevent your computer from overheating make sure nothing blocks the Vent/Fan Intakes while the computer is in use.

On the Road

In addition to the general safety and maintenance suggestions in this preface, and Chapter 8: Troubleshooting, keep these points in mind:

Hand-carry the notebook - For security, don't let it out of your sight. In some areas, computer theft is very common. Don't check it with "normal" luggage. Baggage handlers may not be sufficiently careful. Avoid knocking the computer against hard objects.

Beware of Electromagnetic fields - Devices such as metal detectors & X-ray machines can damage the computer, hard disk, floppy disks, and other media. They may also destroy any stored data - Pass your computer and disks around the devices. Ask security officials to hand-inspect them (you may be asked to turn it on). **Note:** Some airports also scan luggage with these devices.

Fly safely - Most airlines have regulations about the use of computers and other electronic devices in flight. These restrictions are for your safety, follow them. If you stow the notebook in an overhead compartment, make sure it's secure. Contents may shift and/or fall out when the compartment is opened.

Get power where you can - If an electrical outlet is available, use the AC/DC adapter and keep your battery(ies) charged.

Keep it dry - If you move quickly from a cold to a warm location, water vapor can condense inside the computer. Wait a few minutes before turning it on so that any moisture can evaporate.

Developing Good Work Habits

Developing good work habits is important if you need to work in front of the computer for long periods of time. Improper work habits can result in discomfort or serious injury from repetitive strain to your hands, wrists or other joints. The following are some tips to reduce the strain:



- Adjust the height of the chair and/or desk so that the keyboard is at or slightly below the level of your elbow. Keep your forearms, wrists, and hands in a relaxed position.
- Your knees should be slightly higher than your hips. Place your feet flat on the floor or on a footrest if necessary.
- Use a chair with a back and adjust it to support your lower back comfortably.
- Sit straight so that your knees, hips and elbows form approximately 90-degree angles when you are working.
- Take periodic breaks if you are using the computer for long periods of time.



Remember to:

- Alter your posture frequently.
- Stretch and exercise your body several times a day.
- Take periodic breaks when you work at the computer for long periods of time. Frequent and short breaks are better than fewer and longer breaks.

Lighting

Proper lighting and a comfortable viewing angle can reduce eye strain and shoulder and neck muscle fatigue.

- Position the display to avoid glare or reflections from overhead lighting or outside sources of light.
- Keep the display screen clean and set the brightness and contrast to levels that allow you to see the screen clearly.
- Position the display directly in front of you at a comfortable viewing distance.
- Adjust the display-viewing angle to find the best position.

LCD Screen Care

To prevent **image persistence** on LCD monitors (caused by the continuous display of graphics on the screen for an extended period of time) take the following precautions:

- Set the *Windows* **Power Plans** to turn the screen off after a few minutes of screen idle time.
- Use a rotating, moving or blank screen saver (this prevents an image from being displayed too long).
- Rotate desktop background images every few days.
- Turn the monitor off when the system is not in use.

LCD Electro-Plated Logos

Note that in computers featuring a raised LCD electro-plated logo, the logo is covered by a protective adhesive. Due to general wear and tear, this adhesive may deteriorate over time and the exposed logo may develop sharp edges. Be careful when handling the computer in this case, and avoid touching the raised LCD electro-plated logo. Avoid placing any other items in the carrying bag which may rub against the top of the computer during transport. If any such wear and tear develops contact your distributor/supplier.

Contents

Notice	I
ErP Off Mode Power Consumption Statement:	II
FCC Statement	IV
FCC RF Radiation Exposure Statement:	V
Instructions for Care and Operation	VII
Servicing	IX
Power Safety	X
Polymer Battery Precautions	XI
General Battery Precautions	XII
Cleaning	XIII
Cleaning Instructions	XIII
Travel Considerations	XIV

Quick Start Guide

Overview	1-1
Advanced Users	1-2
Beginners and Non-Advanced Users	1-2
Warning Boxes	1-2
Not Included	1-3
Model Differences	1-3
System Startup	1-4

Preface

System Software	1-5
LCD Panel Open - Model A	1-6
LCD Panel Open - Model B	1-7
LCD Panel Open with Fan Area	1-8
OLED Screen Information	1-9
LED Indicators	1-10
Illuminated Color LED Keyboard	1-11
Keyboard Backlight LED Device	1-12
Keyboard Shortcuts	1-13
Function/Hot Key Indicators	1-14
Control Center	1-15
Flexikey® Application	1-16
Front & Left Views	1-17
Right View	1-19
Rear View	1-20
Bottom View - Model A	1-21
Bottom View - Model B	1-22
Windows 10 Start Menu	1-23
Right-Clicking the Windows Logo In Start Menu	1-24
Windows 10 Control Panel	1-26
Settings	1-27
Windows 10 Taskbar	1-28

Action Center1-29

Video Features1-30

Microsoft Hybrid Graphics1-30

Power Options1-36

Features & Components

Overview2-1

Solid State Drive2-2

Micro SD Push-Push Card Reader2-3

Touchpad and Buttons/Mouse2-4

Touchpad Sensitivity2-4

Mouse Properties Control Panel2-5

Mouse & Touchpad Devices2-7

Realtek Audio Console2-14

Realtek Audio Console - Main2-15

Realtek Audio Console - Speakers2-16

Realtek Audio Console - Microphone2-17

Realtek Audio Console - Device Advanced Settings2-18

Power Management

Overview3-1

The Power Sources3-2

AC/DC Adapter3-2

Preface

Battery	3-2
Turning On the Computer	3-3
Shutting the Computer Down	3-4
Power Plans	3-5
Power-Saving States	3-7
Sleep	3-7
Hibernate	3-8
Shut down	3-8
Configuring the Power Buttons	3-9
Resuming Operation	3-11
Settings Menu Power Controls	3-13
Battery Information	3-16
Battery Power	3-16
Power Slider Settings	3-17
Conserving Battery Power	3-18
Battery Life	3-19
New Battery	3-19
Recharging the Battery with the AC/DC Adapter	3-20
Proper handling of the Battery Pack	3-20
Battery FAQ	3-21

Drivers & Utilities

Graphics Mode for Driver Installation	4-1
What to Install	4-2
Module Driver Installation	4-2
Driver Installation	4-3
Updating/Reinstalling Individual Drivers	4-6
User Account Control	4-7
Windows Security Message	4-7
New Hardware Found	4-7
Driver Installation Procedure	4-8
Chipset	4-8
Serial IO	4-8
Intel Video (VGA)	4-8
NVIDIA Video (VGA)	4-9
LAN	4-9
Card Reader	4-9
Intel® HID Filter Driver	4-9
Control Center	4-10
MEI Driver	4-10
Intel® Dynamic Platform Driver	4-10
Creative Sound Blaster Atlas Audio	4-10
Audio	4-11

Preface

Optional Drivers	4-13
------------------------	------

BIOS Utilities

Overview	5-1
The Insyde BIOS Utility	5-2
Updating the BIOS / CPU	5-3
UEFI Boot	5-4
Insyde BIOS Start Screen	5-5
Insyde BIOS Start Screen Options:	5-6
Boot Manager	5-7
Boot From File / File Explorer	5-8
Administer Secure Boot	5-9
Setup Utility - Main Menu	5-11
Setup Utility - Advanced Menu	5-13
Setup Utility - Security Menu	5-19
Setup Utility - Boot Menu	5-22
Setup Utility - Exit Menu	5-24

Modules & Options

Overview	6-1
SATA Mode Setup (Optane™, RAID or AHCI)	6-2
AHCI Mode	6-2
Intel® Optane™	6-2

RAID6-2

Intel® Rapid Storage Technology Application6-3

RAID Setup6-5

Deleting a RAID6-10

Intel® Optane™ Setup Procedure6-11

Wireless LAN Module6-14

Intel® WLAN Driver Installation6-15

Killler WLAN Combo Driver Installation6-16

WLAN Configuration in Windows 106-17

Fingerprint Reader Module6-20

Fingerprint Reader Driver Installation6-21

Fingerprint Module Configuration6-22

Bluetooth & WLAN Combo Module6-24

Intel & Killer Bluetooth Combo Driver Installation6-25

Bluetooth Configuration in Windows6-26

To Make your Computer Discoverable to Bluetooth Devices6-29

Thunderbolt Port Driver6-30

Intel® Software Guard Extensions Driver6-32

Intel SGX Driver Installation6-32

Intel® Rapid Storage Technology6-33

IRST Driver Installation6-33

Intel® Rapid Storage Technology Apps6-34

Preface

Intel® Optane™ Memory & Storage Management	6-35
Enabling Intel® Optane™ (Intel® Optane™ Memory & Storage Management)	6-37
Intel® Rapid Storage Technology for RAID Systems	6-40
RAID Volume Data Verification and Repair	6-42
Replacing and Reverting Recovery and Master Volumes	6-42
Intel® Rapid Storage Technology for Optane Systems	6-45
Enabling Intel® Optane™	6-46
Disabling Intel® Optane™	6-49
Sound Blaster Audio	6-51
Sound Blaster Atlas Audio AP Installation	6-51
Sound Blaster Atlas Application	6-52
SBX Profile	6-53
Equalizer	6-55
Playback	6-56
Recording - Voice Morph	6-57
Scout Mode	6-58
SoundFit	6-59
Settings	6-60
PC Camera	6-61
Camera App	6-62
Taking Pictures/Capturing Video	6-66
Trusted Platform Module	6-68

Enabling & Activating TPM	6-69
TPM Management in Windows	6-70
TPM Actions	6-72

Troubleshooting

Overview	7-1
Basic Hints and Tips	7-2
Backup and General Maintenance	7-3
Viruses	7-4
Upgrading and Adding New Hardware/Software	7-5
Problems and Possible Solutions	7-7
Intel® Optane™ Notes	7-15
OLED Screen Information	7-16

Interface (Ports & Jacks)

Overview	A-1
Ports and Jacks	A-2

Control Center

Overview	B-1
Power Modes	B-4
LED Keyboard	B-5
LED Keyboard - Illuminated Colored LED Keyboards	B-6

Preface

LED Device Menu - Illuminated Colored “Per Key” LED Keyboards	B-8
Flexikey® Application	B-10
Profiles	B-10
Keyboard Macro and Mouse Macro Settings	B-11
Enabling or Disabling Flexikey®	B-11
Keyboard Macro	B-12
Mouse Macro	B-13
Keyboard Macro - Express Key	B-14
Keyboard Macro - Express Text	B-18
Keyboard Macro - Disable	B-20
Mouse Macro - Express Key	B-21
Mouse Macro - Express Text	B-22
Mouse Macro - Disable	B-23
Statistics	B-24

Video Driver Controls

Overview	C-1
Microsoft Hybrid Graphics	C-2
Video Driver Installation	C-4
Intel Video (VGA)	C-4
NVIDIA Video (VGA)	C-5
NVIDIA GeForce Experience	C-6

NVIDIA GeForce Experience - BatteryBoost	C-7
Configure Other Displays Using Project	C-8
Configuring an External Display In Windows	C-9
HDMI Audio Configuration	C-11
Wireless Display	C-14
Wireless Display Configuration	C-15
NVIDIA Control Panel	C-17
Customization Options	C-21
Change Resolution	C-25
Display Devices - NVIDIA CP	C-26
Configuring an External Display (NVIDIA)	C-28
HDCP Status	C-32
Adjust Video Settings	C-33
Configure Surround, PhysX®	C-34
Set Digital Audio	C-35
Intel® Graphics Command Center	C-36
Intel Graphics Command Center Display Devices	C-49
Attaching Other Displays	C-50

Specifications

Core Logic	D-2
Display	D-2

Preface

Memory	D-2
Storage	D-2
Audio	D-2
Pointing Device & Keyboard	D-2
Interface	D-2
Card Reader	D-3
Slots	D-3
Communication	D-3
Power Management	D-3
Power & Battery	D-3
Security	D-3
Features (For Some Model Designs)	D-3
Indicators	D-3
Operating System	D-4
BIOS	D-4
Environmental Spec	D-4
Dimensions & Weight	D-4

Chapter 1: Quick Start Guide

Overview

This Quick Start Guide is a brief introduction to the basic features of your computer, to navigating around the computer and to getting your system started. The remainder of the manual covers the following:

- **Chapter 2** A guide to using some of the main features of the computer e.g. the **storage devices (hard disk, optical device, Multi-in-1 card reader), TouchPad & Mouse & Audio.**
- **Chapter 3** The computer's **power** saving options.
- **Chapter 4** The installation of the **drivers** and utilities essential to the operation or improvement of some of the computer's subsystems.
- **Chapter 5** An outline of the computer's built-in software or **BIOS** (Basic Input Output System).
- **Chapter 7** A quick guide to the computer's **PC Camera, Wireless LAN, Combo Bluetooth & WLAN, TPM (security)** and **Intel** modules (some of which may be **optional** depending on your purchase configuration).
- **Chapter 7** A **troubleshooting** guide.
- **Appendix A** Definitions of the **interface, ports/jacks** which allow your computer to communicate with external devices.
- **Appendix B** Information on **Control Center.**
- **Appendix C** Information on the **Video driver controls.**
- **Appendix D** The computer's **specification.**

Advanced Users

If you are an advanced user you may skip over most of this Quick Start Guide. However you may find it useful to refer to *“What to Install” on page 4 - 2* and *“BIOS Utilities” on page 5 - 1* in the remainder of the User’s Manual. You may also find the notes marked with a  of interest to you.

Beginners and Non-Advanced Users



Notes

Check the light colored boxes with the mark above to find detailed information about the computer’s features.

If you are new to computers (or do not have an advanced knowledge of them) then the information contained in the Quick Start Guide should be enough to get you up and running. Eventually you should try to look through all the documentation (more detailed descriptions of the functions, setup and system controls are covered in the remainder of the User’s Manual), but do not worry if you do not understand everything the first time. Keep this manual nearby and refer to it to learn as you go. You may find it useful to refer to the notes marked with a  as indicated in the margin. For a more detailed description of any of the interface ports and jacks see *“Interface (Ports & Jacks)” on page A - 1*.

Warning Boxes

No matter what your level please pay careful attention to the warning and safety information indicated by the  symbol. Also please note the safety and handling instructions as indicated in the *Preface*.

Not Included

Operating Systems (e.g. *Windows 10*) and applications (e.g. word processing, spreadsheet and database programs) have their own manuals, so please consult the appropriate manuals.



Drivers

If you are installing new system software, or are re-configuring your computer for a different system, you will need to install the drivers listed in ***“Drivers & Utilities” on page 4 - 1***. Drivers are programs which act as an interface between the computer and a hardware component e.g. a wireless network module. It is very important that you install the drivers in the order listed. You will be unable to use most advanced controls until the necessary drivers and utilities are properly installed. If your system hasn't been properly configured (your service representative may have already done that for you); refer to ***Chapter 4*** for installation instructions.

Ports and Jacks

See ***“Interface (Ports & Jacks)” on page A - 1*** for a description of the interface (ports & jacks) which allow your computer to communicate with external devices, connect to the internet etc.

Model Differences

This notebook series includes **two different screen size models**, and **four different designs** for each model, based on specification, and these may vary slightly in appearance. Note that though your computer may look slightly different from that pictured throughout this manual, all ports, jacks (other than those indicated in the specification) and general functions are the same for all the design styles (see ***Appendix D*** for further details).

System Startup

1. Remove all packing materials, and place the computer on a stable surface.
2. Securely attach any peripherals you want to use with the notebook (e.g. keyboard and mouse) to their ports.
3. **When first setting up the computer use the following procedure** (as to safeguard the computer during shipping, the battery will be locked to not power the system until first connected to the AC/DC adapter and initially set up as below):
 - Attach the AC/DC adapter cord to the DC-In jack at the rear of the computer, then plug the AC power cord into an outlet, and connect the AC power cord to the AC/DC adapter and the battery will now be unlocked.
4. Use one hand to raise the lid/LCD to a comfortable viewing angle (**do not exceed 130 degrees**); use the other hand to support the base of the computer (**Note: Never** lift the computer by the lid/LCD).



Shutdown

Note that you should always shut your computer down by choosing the **Shut Down** command in **Windows** (see page [1 - 35](#)). This will help prevent hard disk or system problems.

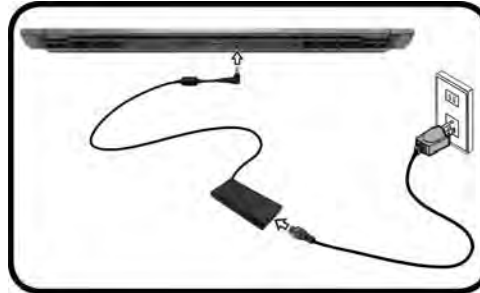

Figure 1 - 1 - Computer with AC/DC Adapter Plugged-In & LCD/Lid Open

System Software

Your computer may already come with system software pre-installed. Where this is not the case, or where you are re-configuring your computer for a different system, you will find the **Windows 10 (64-bit)** operating system is supported.



Windows OS

Note that the information included on the following pages is for **Windows 10 only**.

In order to run **Windows 10 (64-bit)** your computer requires a minimum **8GB** of system memory (RAM).

LCD Panel Open - Model A

Figure 1 - 2
LCD Panel Open

1. Built-in PC Camera
2. PC Camera LED
3. Built-In Array Microphone
4. LCD
5. Power Button
6. Keyboard
7. Touchpad & Buttons
8. Fingerprint On Glass Reader Sensor (**Factory Option**)



Note that the Touchpad and Buttons has a valid operational area indicated within the red dotted lines above.



Wireless Device Operation Aboard Aircraft

The use of any portable electronic transmission devices aboard aircraft is usually prohibited. Make sure the **WLAN & Bluetooth module(s) are OFF** if you are using the computer aboard aircraft by putting the system in to **Airplane Mode** (see [Table 1 - 4](#), on [page 1 - 14](#)).



LCD Panel Open - Model B





**Wireless Device
Operation Aboard
Aircraft**

The use of any portable electronic transmission devices aboard aircraft is usually prohibited. Make sure the **WLAN & Bluetooth module(s) are OFF** if you are using the computer aboard aircraft by putting the system in to **Airplane Mode** (see *Table 1 - 4, on page 1 - 14*).

Figure 1 - 3
LCD Panel Open

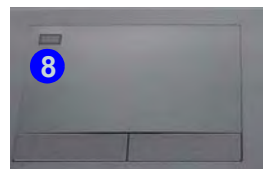
1. Built-in PC Camera
2. PC Camera LED
3. Built-In Array Microphone
4. LCD
5. Power Button
6. Keyboard
7. Touchpad & Buttons
8. Fingerprint Reader Sensor



Note that the Touchpad and Buttons has a valid operational area indicated within the red dotted lines above.

Figure 1 - 4
LCD Panel Open
with Fan Area

1. Vent/Fan Intake/
Outlet



Overheating

To prevent your computer from overheating make sure nothing blocks or covers the Vent/Fan Intake **1** while the computer is in use.

LCD Panel Open with Fan Area



OLED Screen Information

For the long term care of, and display quality on, OLED screens note the following:

- It is highly recommended that you enable “Automatically hide the taskbar in desktop mode” (Settings > Personalization > Taskbar).
- Use the Power & sleep Settings to turn off the screen after a short period of inactivity.
- Use a medium level of brightness.
- Use a screensaver (specific pieces of motion content designed to combat burn-in) application.
- Change the screen background picture from time to time (and the Lock Screen picture in Personalization settings).

LED Indicators

The LED indicators display helpful information about the current status of the computer.



Icon	Color	Description
	Green	Storage Device Activity
	Orange	The Battery is Charging
	Blinking Orange	The Battery has Reached Critically Low Power Status
	Green	The Battery is Fully Charged
	Orange	AC/DC Power is Plugged In
	Blinking Orange*	The Powered USB Port is On (see “Powered USB Port” on page 1 - 17)
	Green	The Computer is On
	Blinking Green	The Computer is in Sleep Mode

Table 1 - 1 - LED Indicators

Illuminated Color LED Keyboard

The **illuminated colored** keyboard has an embedded numerical keypad for easy numeric data input, and features function keys to allow you to change operational features instantly. See *Table 1 - 4, on page 1 - 14* for full function key combination details, and see *“Illuminated Color LED Keyboard” on page 1 - 11*.



Figure 1 - 5 - Illuminated Color LED Keyboard

Special Characters

Some software applications allow the number-keys to be used with **Alt** to produce special characters. These special characters can only be produced by using the numeric keypad. Regular number keys (in the upper row of the keyboard) will not work. Make sure that **NumLk** is on.



Other Keyboards



If your keyboard is damaged or you just want to make a change, you can use any standard USB keyboard. The system will detect and enable it automatically. However special functions/hot-keys unique to the system's regular keyboard may not work.

Scr Lk

Hold down the **Fn Key** and **Scr Lk** to enable scroll lock and check the LED indicator for status.

Keyboard Backlight LED Device

(For Illuminated Colored Keyboards Only)

Press **Fn** plus the  **2** key to toggle the keyboard LED on/off. The keyboard LED may be configured using the **Fn + key combination** outlined in the table below. In addition press **Fn** plus the  **1** key to launch the keyboard backlight application to configure the settings.





Main Keyboard Colored LED Function key Combinations		
Fn + 	1 Launch the Keyboard Backlight Application	
Fn + 	2 Toggle the Keyboard Backlight LED On/Off	
Fn + 	3 Keyboard Backlight LED Low	
Fn + 	4 Keyboard Backlight LED High	

Table 1 - 2 - Main Keyboard LEDs (for Illuminated Colored Keyboards Only)

Keyboard Shortcuts

The following Windows Logo Key (Winkey) keyboard shortcuts are useful for navigation/operation in *Windows 10*.



Windows Logo  Key +	Description
Tap Winkey	Toggle the Start menu
A	Open the Action Center
B	Select the Taskbar Notification Area
D	Toggle the Desktop
E	Launch File Explorer (Quick Access tab)
+ Number (1, 2, etc)	Launch an application from the taskbar (numbered from left to right)

Table 1 - 3 - Keyboard Shortcuts



Menu/Application Keyboard Shortcut

When the Desktop app is running you can use the Menu/Application key  on the keyboard to display the context menu as per a mouse right-click.

Function/Hot Key Indicators



















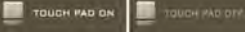

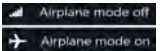



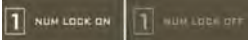

Keys	Function	Keys	Function
Fn + 	Play/Pause (in Audio/Video Programs)	Fn +  	Display Brightness Decrease/Increase 
Fn + 	*Fan Control Toggle Automatic Fan Control / Full Power / Max-Q* (*NVIDIA video adapter dependent)	Fn + 	PC Camera Power Toggle 
Fn + 	Touchpad Toggle 	Fn + 	Airplane Mode Toggle 
Fn + 	Turn LCD Backlight Off (Press a key to or use TouchPad to turn on)	Fn + 	Sleep Toggle
Fn + 	Mute Toggle 		Number Lock Toggle 
Fn +  	Volume Decrease/Increase 		Scroll Lock Toggle 
Fn + 	Change Display Configuration		Caps Lock Toggle 
Fn + 	Control Center Toggle	Fn + 	Flexikey® Enable/Disable 
Fn + Power Button	Powered USB 3.0 Port Power Toggle	*Note: It is recommended that you use Maximum fan speed when playing games (use Fn + 1)	
The function keys (F1 - F12 etc.) will act as hot keys when pressed while the Fn key is held down			

Table 1 - 4 - Function & Hot Key Indicators

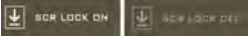
Control Center

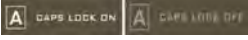

Run the **Control Center** from the **Windows Start** menu  or use the **Fn + Esc** key combination, or double-click the icon  in the notification area of the taskbar. The **Control Center** provides quick access to **Power Modes**, **Fan settings** and **LED Keyboard configuration** (see [Appendix B](#)).



Figure 1 - 6 - Control Center

Flexikey® Application

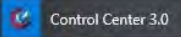
The Flexikey® application is a quick hotkey configuration application, which allows you to **assign a single key to launch multiple key combinations**, to **create text macros** and to **disable** certain keys. The application can also be used to **configure the mouse buttons** to create hotkeys for gaming etc. Click **Flexikey** in the **Control Center** or **Start** menu to launch the application (see [Appendix B](#) for full details).



Figure 1 - 7 - Flexikey® Application



Windows Key 
Fn & P Keys

Note that you can assign actions to any keyboard key except the Windows key  Fn and P key.

Front & Left Views



Figure 1 - 8
Front & Left Views

1. LED Indicators
2. Security Lock Slot
3. Vent/Fan Intake/Outlet
4. Micro SD Push-Push Card Reader
5. Powered USB 3.2 Gen 1 (Type A) Port
6. 2-In-Audio Jack (Headphone/Microphone)
7. 2-In-Audio Jack (Microphone / S/PDIF-Out Jack)



Powered USB Port

Note that the powered USB 3.2 (Type A) port is not operational under DOS and does not support wake on USB. The **powered USB 3.2 (5)** port can supply power (**for charging devices only, not for operating devices**) when the system is off but still powered by the AC/DC adapter plugged into a working outlet, or powered by the battery with a capacity level above 20% (this may not work with certain devices - see page 7 - 11). Toggle power to this port by using **Fn + power button**.

Micro SD Push-Push Card Reader

The card reader allows you to use some of the latest microSD digital storage cards. Push the card into the slot and it will appear as a removable device. The compatible microSD card formats are listed below:

- microSD / microSDHC / microSDXC (Up to UHS-II)



Combination Audio Jacks

Note that the combination audio jacks can support a microphone, headphone, S/PDIF device or headset (i.e. a combination microphone/headphone).

1. When a device is plugged in to the combination audio jack a dialog (“Which device did you plug in?”) box will pop-up.

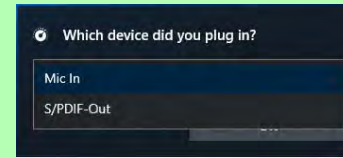
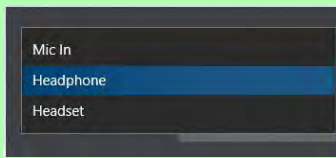
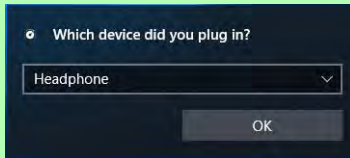

2. Select the appropriate device from the drop-down menu according to the device plugged-in (e.g. Headset), and then click **OK** to save the setting.

Right View



Figure 1 - 9
Right View

1. USB 3.2 Gen 1 (Type A) Port
2. RJ-45 LAN Jack
3. Vent/Fan Intake/Outlet



USB Ports

USB sports capable of 5Gbps (SuperSpeed) are classified as USB 3.2 Gen 1. **There are three USB 3.2 Gen 1 (Type A) ports on this computer model, including a powered USB port.**



Overheating

To prevent your computer from overheating make sure nothing blocks the Vent/Fan Intake while the computer is in use. In particular, make sure that the adapter cable does not block the rear vent.

Quick Start Guide

Figure 1 - 10

Rear View

1. Vent/Fan Intake
2. Mini DisplayPort 1.4
3. HDMI-Out Port
4. DC-In Jack
5. Thunderbolt™ 3 Port

Rear View

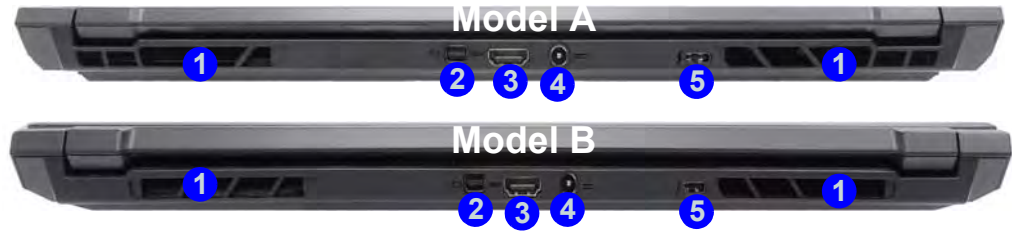

Mini DisplayPort Cables

When using cables connected to the Mini DisplayPort, **try to make sure that the cables are not bent excessively**, as bending the cables may cause signal problems.



Thunderbolt Port Devices

If your purchase option includes a Thunderbolt port note the following:

When plugging a device into a Thunderbolt port allow 30 seconds for the system to scan and recognize the connected device. Double-click the **Thunderbolt Control Center**  **Thunderbolt Control Center** in the Start menu.

Ejecting Thunderbolt Devices

In order to prevent system problems make sure you **do not simply pull the cable out from the Thunderbolt port**. The hardware must be ejected safely:

1. Go to the notification area of the taskbar in and click on the **Safely Remove Hardware and Eject Media** icon.
2. Click on Eject "*Thunderbolt Device Name*".
3. When you see the "**Safe to Remove Hardware**" message **you can remove the cable after about 20 seconds**, to make sure that it is safe to eject the device.

The security level configuration for the Thunderbolt port can be set up in the BIOS (see "*Security Level (Advanced Menu > Thunderbolt(TM) Configuration*")" on page 5 - 18).

Bottom View - Model A

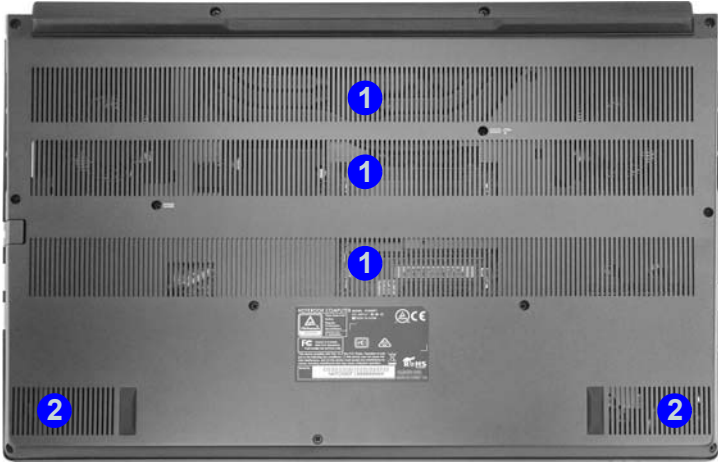



Overheating

To prevent your computer from overheating make sure nothing blocks the Vent/Fan Intake while the computer is in use.

Figure 1 - 11
Bottom View

1. Vent/Fan Intake/ Outlet
2. Speakers



Bottom Cover Removal Warning

Do not remove any cover(s) and /or screw(s) for the purposes of device upgrade as this may violate the terms of your warranty.

If you need to replace/remove the hard disk/RAM/optical device etc., for any reason, please contact your distributor/supplier for further information.



Battery Information

Always completely discharge, then fully charge, a new battery before using it. Completely discharge and charge the battery at least once every 30 days or after about 20 partial discharges.

See **“Battery Information” on page 3 - 16** for full instructions. This model’s battery is embedded and cannot be removed without violating the terms of your warranty. Contact your distributor/supplier for details.

Quick Start Guide

Figure 1 - 12
Bottom View

1. Vent/Fan Intake/Outlet
2. Speakers

Bottom View - Model B

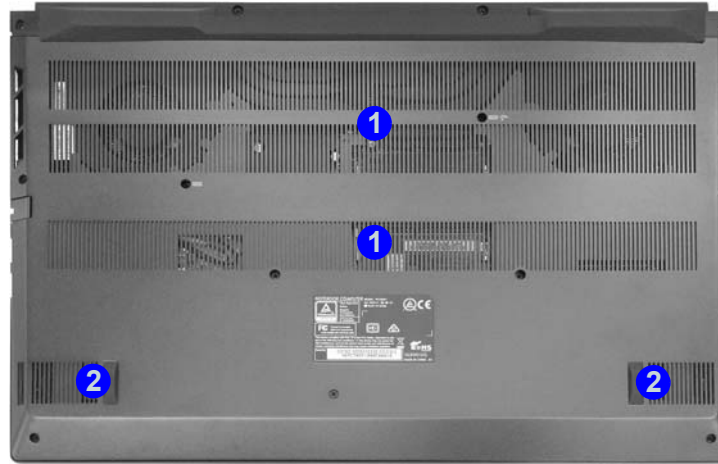

Overheating

To prevent your computer from overheating make sure nothing blocks the Vent/Fan Intake while the computer is in use.



Battery Information

Always completely discharge, then fully charge, a new battery before using it. Completely discharge and charge the battery at least once every 30 days or after about 20 partial discharges.

See ***“Battery Information”*** on page 3 - 16 for full instructions. This model's battery is embedded and cannot be removed without violating the terms of your warranty. Contact your distributor/supplier for details.





Bottom Cover Removal Warning

Do not remove any cover(s) and /or screw(s) for the purposes of device upgrade as this may violate the terms of your warranty.

If you need to replace/remove the hard disk/RAM/optical device etc., for any reason, please contact your distributor/supplier for further information.

Windows 10 Start Menu

Most of the apps, control panels, utilities and programs within *Windows 10* can be accessed from the **Start Menu** by clicking the icon  in the taskbar in the lower left corner of the screen (or by pressing the **Windows Logo Key**  on the keyboard). The Start Menu will contain a number of apps, and many more will be installed as you add more applications etc. Not all of these apps may fit on the screen so you can use the scroll bar to move up and down the screen.

Windows Screens



Note that the *Windows* screens on the following pages are included as a basic guide and introduction to navigating around *Windows 10*.

However note that these screens are always subject to change, upgrade and redesign. Check the Microsoft website for details.



Figure 1 - 13 - Windows Start Menu

Right-Clicking the Windows Logo In Start Menu

Right-click the Start Menu  icon (or use the **Windows Logo Key**  + **X** key combination) to bring up an advanced **Context Menu** of useful features such as Apps and Features, Power Options, Task Manager, Search, File Explorer, Device Manager, Computer Management and Network Connections etc.

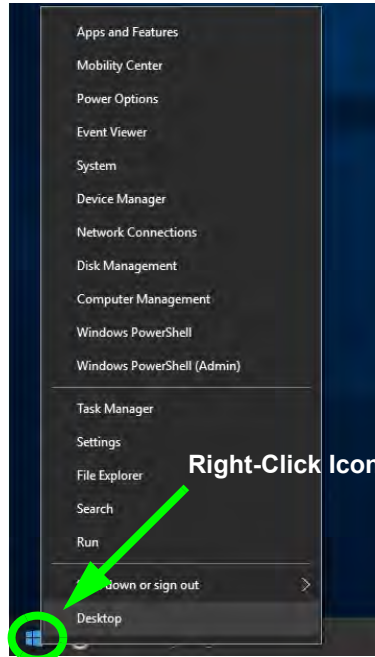

Figure 1 - 14 - Right-Click Windows Logo in Start Menu

Pining/Unpinning Apps & Programs to/from the Start Menu

To make things easy to find you can add and remove tiles for apps and programs to the Start Menu. Right-Click on a program's icon and select **Pin to Start** from the drop-down menu. To remove an app or program from the Start Menu right-click the icon and select **Unpin from Start**. You can use the same method to **pin apps/programs to/from the taskbar** (select pin to taskbar/unpin this program from the taskbar).

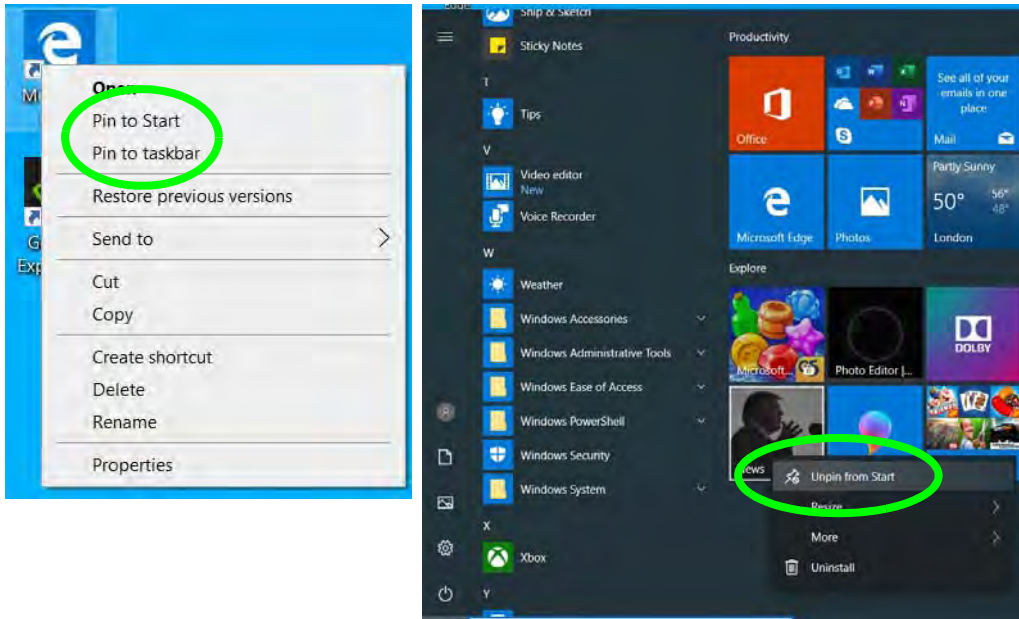

Figure 1 - 15 - Pin to Start/Unpin from Start

Windows 10 Control Panel

In many instances throughout this manual you will see an instruction to open the **Control Panel**. The Control Panel can be accessed in a number of ways in *Windows 10*.

- Select *Control Panel* under the **Windows System** item in the **Start Menu**.
- Type *Control Panel* into the **Search** box in the taskbar and click on the icon when it pops up.
- You can pin the *Control Panel* tile to **Start** or **taskbar**.

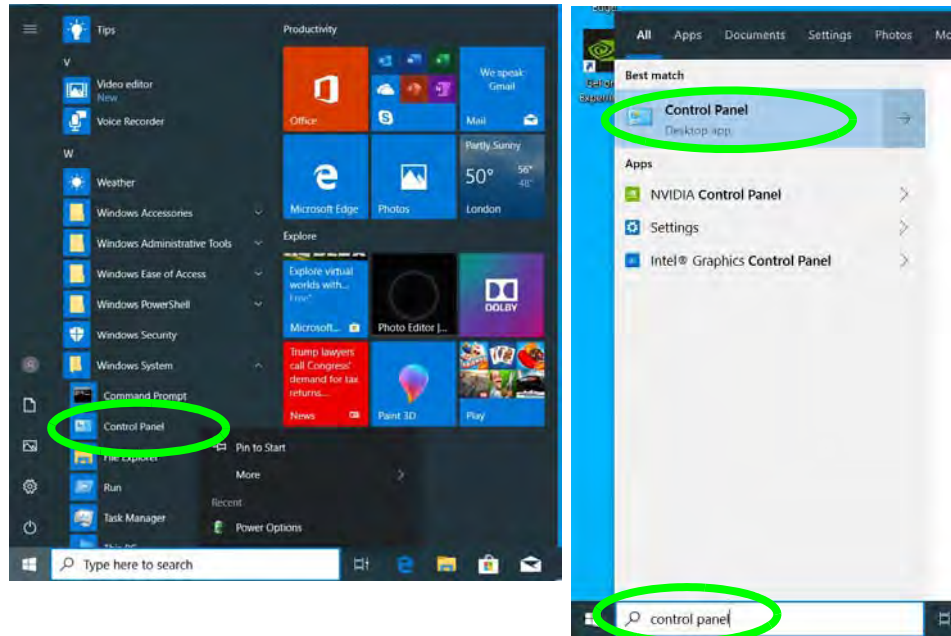

Figure 1 - 16 - Windows 10 Control Panel Access

Settings

The **Settings** item in the Start Menu (and also as an app) gives you quick access to a number of system settings control panels allowing you to adjust settings for System, Devices, Network & internet, Personalization, Apps, Accounts, Time & language, Gaming, Ease of Access, Privacy and Update & security.

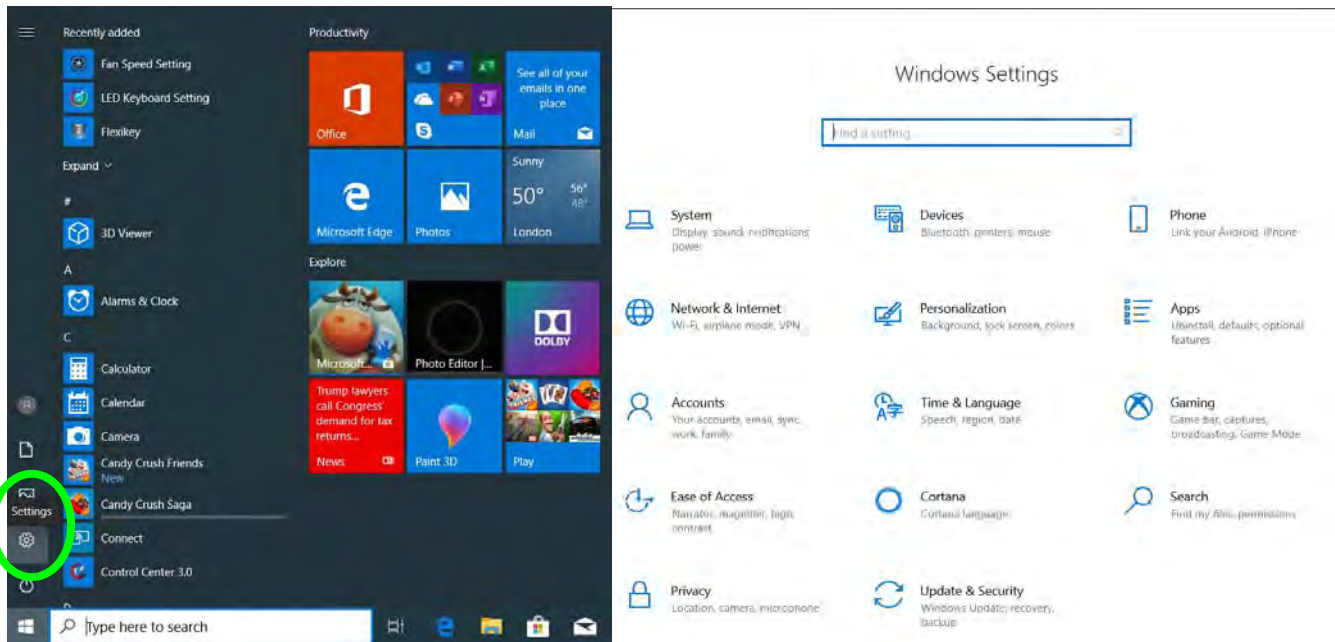

Figure 1 - 17 - Settings

Windows 10 Taskbar

In many instances throughout this manual you will see an instruction to access the **notification area of the taskbar**. The notification area of the taskbar is in the bottom right of the screen. Some of the Control Panels and applications referred to throughout the course of this manual can be accessed from here.



Taskbar



Taskbar - Pinned Programs and Apps

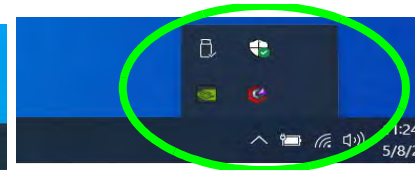

Notification Area

Figure 1 - 18 - Taskbar

You can pin/unpin apps to/from the taskbar in much the same way as you can to the Start screen (see *[“Pining/Unpinning Apps & Programs to/from the Start Menu” on page 1 - 25](#)*).

Action Center

The **Action Center** appears as a vertical panel on the right side of the screen (click **Expand** to view the full panel) when you swipe in from the right or click the button in the notification tray. This gives you access to commonly needed functions like Network, All Settings, Airplane Mode, and Project etc. The Action Center also contains a **Brightness** slider when expanded.

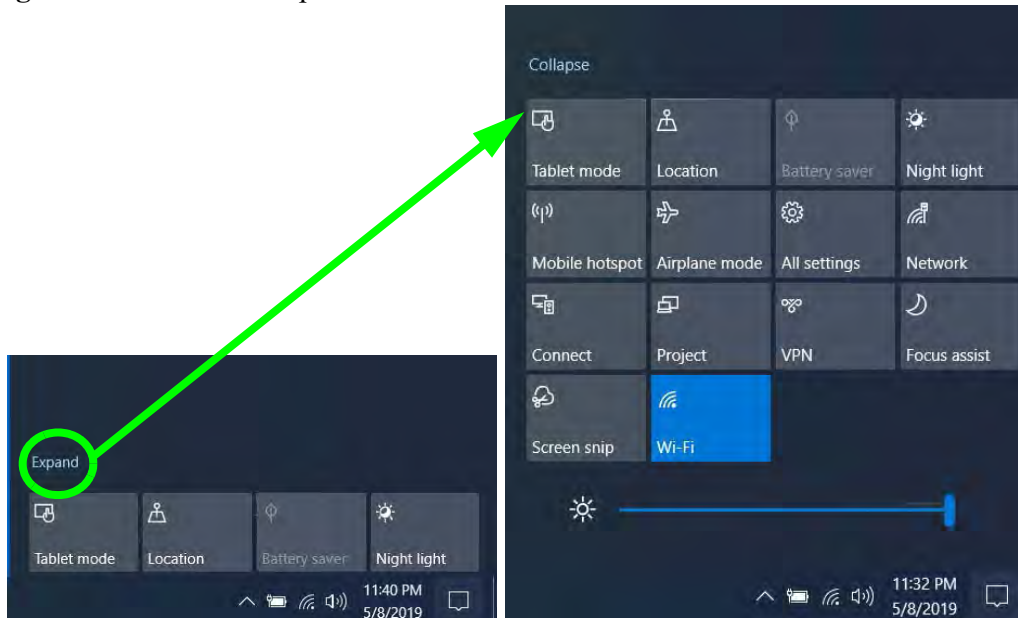



Figure 1 - 19 - Action Center

Video Features

You can switch display devices, and configure display options, from the **Display settings** (click the **Start Menu** and click **Settings** > **System** or right-click the desktop and select **Display settings**) control panel (see over). In *Windows 10* it is possible to quickly configure external displays from the **Project** menu (press the Windows logo key  on your keyboard and the **P** key or **Fn + F7**).

Microsoft Hybrid Graphics

Your computer will feature **Microsoft Hybrid Graphics** switchable graphics technology. This seamless technology is designed to get best performance from the graphics system while allowing longer battery life, without having to manually change settings. The computer's operating system (and some applications) will **automatically** switch between the integrated UMA (Unified Memory Architecture) GPU (**iGPU**) and the discrete GPU (**dGPU**) when required by the applications in use. This switch is seamless to the user (see [Appendix C](#)).

To Configure Displays using Project

1. Attach your display to the appropriate port, and turn it on.
2. Press the **Windows + P** (or **Fn + F7**) key combination.
3. Click on any one of the options from the menu to select **PC screen only**, **Duplicate**, **Extend** or **Second screen only**.
4. You can also click **Connect to a wireless display** at the bottom of the **Project** screen and follow the steps to connect to any wireless enabled display.

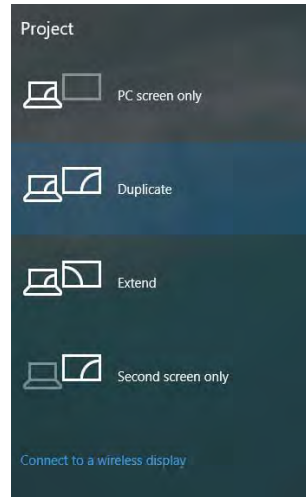

Figure 1 - 20 - Project (Devices)



Configuring External Displays

You can use the **System** (in **Settings** - page **C - 9**) control panel or the **Windows + P** (or **Fn + F7** - page **C - 8**) key combination, to configure an external display.

External displays can also be configured the **Intel(R) Graphics Command Center** (see page **C - 49**).

You can also use the **NVIDIA** (see page **C - 26**) control panel to configure the external displays.

Quick Start Guide

To access the **Display Settings**:

1. You can quickly adjust the display by right-clicking the desktop and selecting **Display Settings**.
2. Adjust the settings for **Brightness and color**, **Scale and layout**, **Resolution** and **Orientation** from the menus.
3. When an external display is attached you can arrange the display configuration from the **Multiple Displays** menu, and arrange the configuration from **Select and rearrange displays**.
4. Click **Apply** to save any changes made.

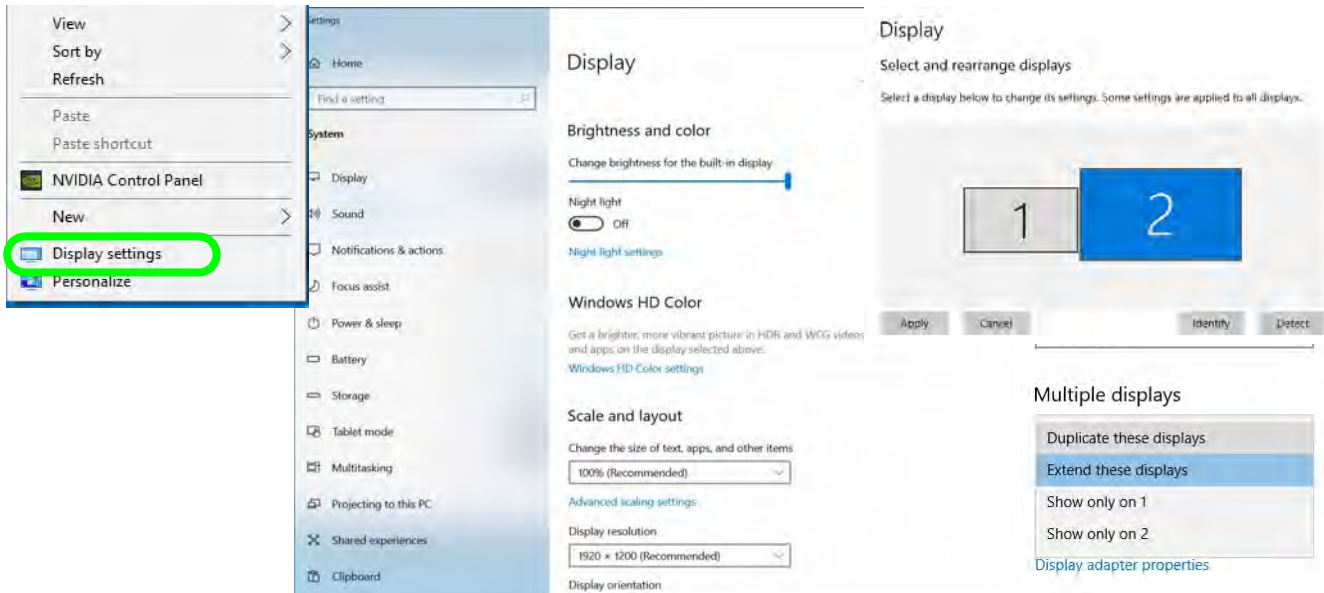

Figure 1 - 20 - Display Settings

To access the *Intel(R) Graphics Command Center*:

1. Access the **Intel Graphics Command Center** from the **Start** menu in **Windows**.
2. You can **right-click** the **Intel Graphics Command Center** in the Start menu and pin the control panel to Start and/or taskbar.

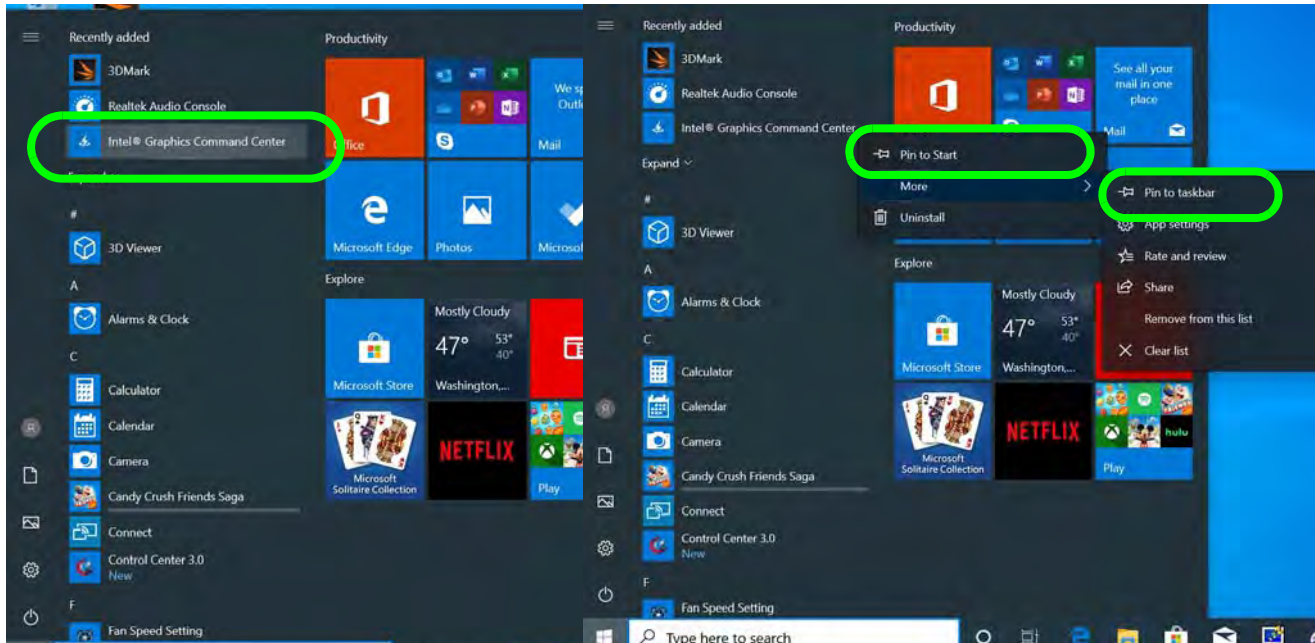

Figure 1 - 21 - Intel® Graphics Command Center Access

Quick Start Guide

To access the *NVIDIA Control Panel*:

1. Access the **NVIDIA Control Panel** from the **Start** menu in **Windows** (or right-click the desktop and select **NVIDIA Control Panel**).

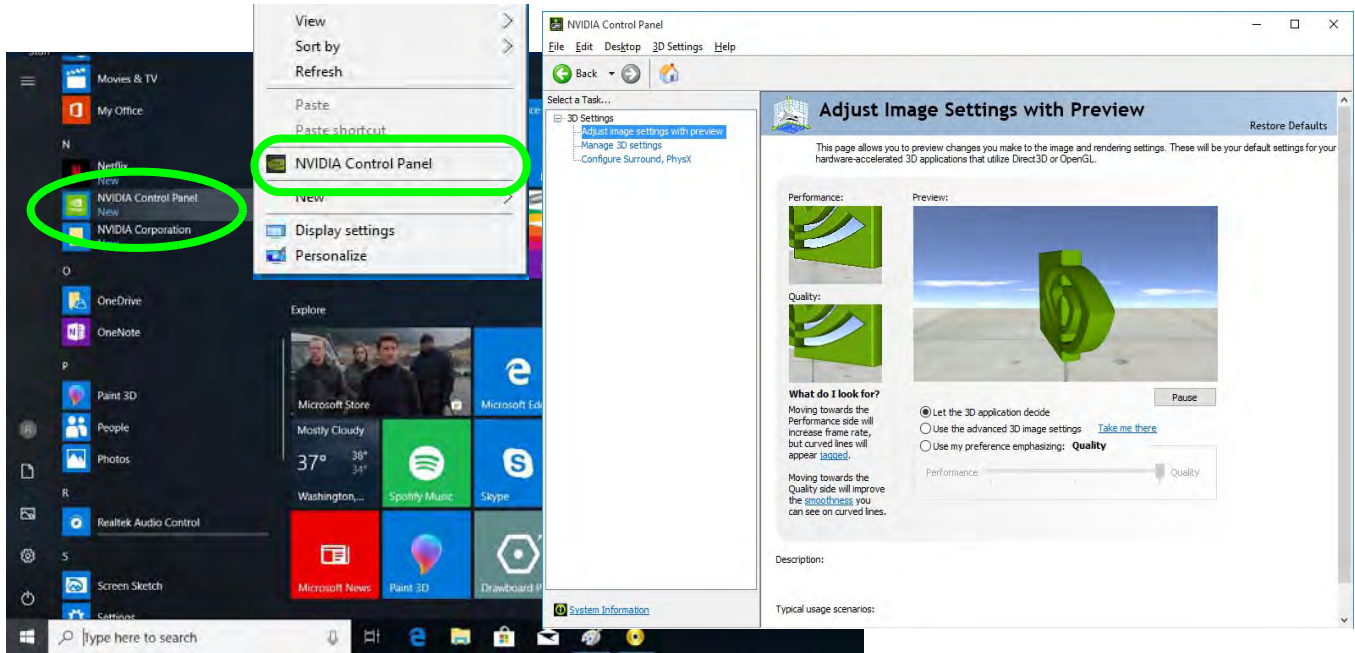

Figure 1 - 22 - NVIDIA Control Panel

Minimum Screen Resolution Settings

1. **Windows 10** has minimum screen resolution requirements.
2. Right-click a blank area of the Desktop and select **Display Settings**.
3. Adjust the **Display Resolution** to make sure that it is at least **1024 * 768**, although preferably **1366 * 768** or above.

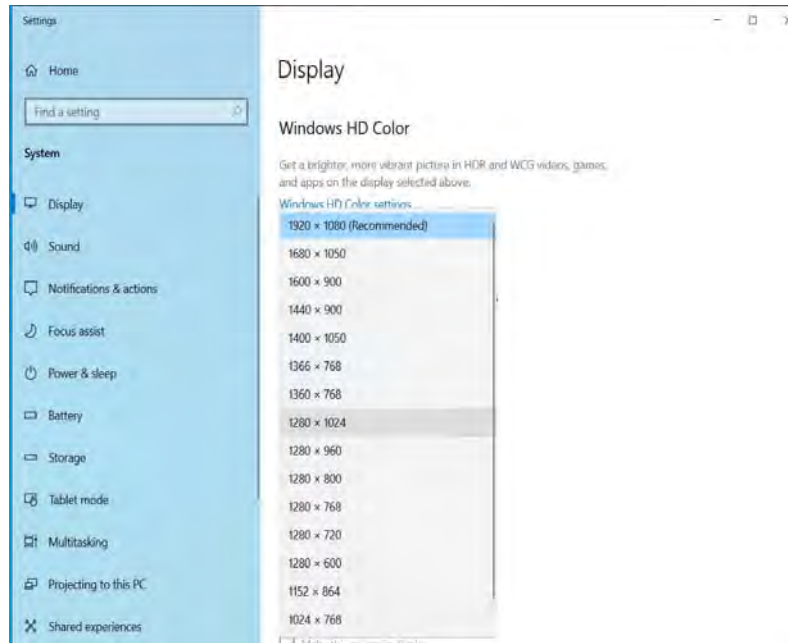



Figure 1 - 23 - Display (Resolution)

Power Options

Power Options (Hardware and Sound) can be accessed from the Control Panel. The **Power** button item in **Start Menu** (or the context menu) may be used to **Shut down** or **Restart** (you can also add **Hibernate/Sleep** to the menu - see page *1 - 37*). To fully control all the power options (including Hibernate mode) go to the **Power Options** control panel and configure the power button, sleep button and lid to perform the function selected.

Using the Power Button

1. Go to the **Start Menu**.
2. Click the **Power button** .
3. Select the power state required from the menu.

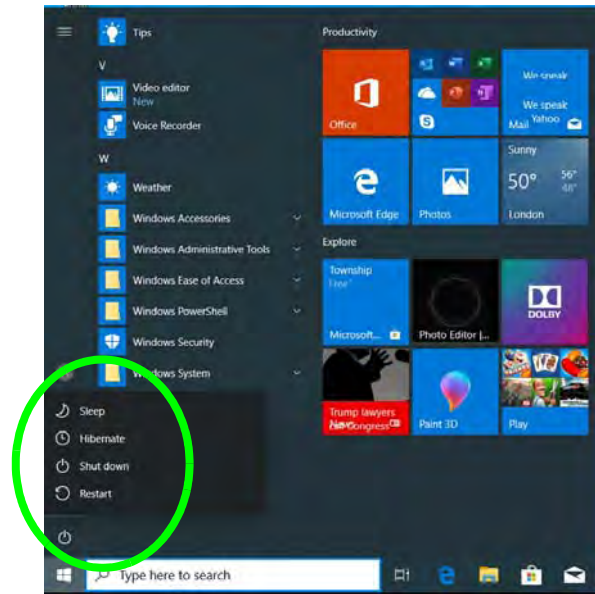

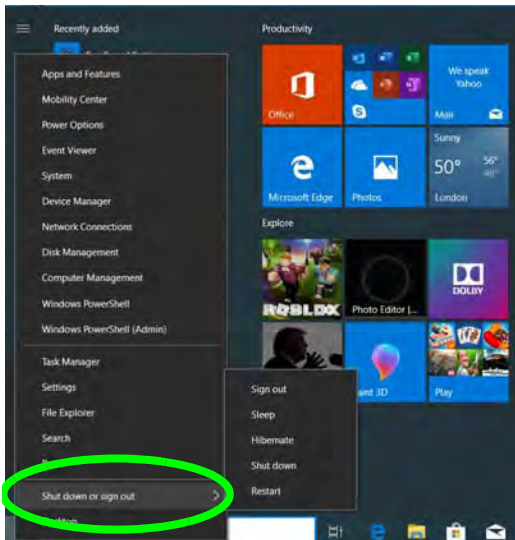

Figure 1 - 24 - Shut Down/Restart

You can also use the **context menu** (right-click the Start Menu  icon or press the Windows logo  + X key combination) to **Sign out, Sleep, Hibernate, Shut down, and Restart.**



Adding Hibernate/Sleep to the Power Menu

1. Go to the **Power Options (Hardware and Sound)** control panel (or go to **Windows Settings > Power & sleep > Additional power settings**).
2. Click **Choose what the power buttons do**.
3. Click **"Change settings that are currently unavailable"**

4. Click to put a check in the **Hibernate/Sleep** box under **Shutdown settings**.
5. Click **Save Changes** and close the control panel.

Figure 1 - 25 - Context Menu Shut Down or sign out

Ctrl + Alt + Delete Key Combination

You can use the **CTRL + ALT + DEL** key combination to bring up a full-screen displaying **Lock, Sign out, Change a password, Task Manager and Switch User**. If you click the **Power** icon in the lower right corner of the screen a power management option menu appears to display **Sleep, Hibernate, Shut down, and Restart**.

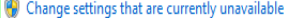
Chapter 2: Features & Components

Overview

Read this chapter to learn more about the following main features and components of the computer:

- Solid State Drive
- Micro SD Push-Push Card Reader
- Touchpad and Buttons/Mouse
- Realtek Audio Console



Bottom Cover Removal Warning

Do not remove any cover(s) and /or screw(s) for the purposes of device upgrade as this may violate the terms of your warranty.

If you need to replace/remove the hard disk for any reason, please contact your distributor/supplier for further information.

Solid State Drive

The solid state drive is used to store your data in the computer. The SSD can be taken out to accommodate other solid state drives, however you will need to contact your distributor/supplier to do this in order to avoid violating the terms of your warranty (see *“Storage” on page D - 2* for specification information).

Micro SD Push-Push Card Reader

The **Micro Secure Digital (SD)** card reader allows you to use some of the latest digital storage cards. Push the card into the slot and it will appear as a removable device, and can be accessed in the same way as your hard disk (s). Make sure you install the card reader driver (see *“Card Reader” on page 4 - 9*).



Push-Push Card Reader

The card reader features a push-in/push-out card insertion and ejection mechanism. Simply push the card to insert and eject it, however Ms Duo cards require an adapter.

1. Card Reader

Figure 2 - 1
Left View



Touchpad Cleaning

In order to improve pad performance it is necessary to keep the surface clean and free of fingerprints and marks etc.

Use a soft dry cleaning cloth to keep the pad surface clean.

Disabling the Pad

Use the **Fn + F1** or Control Center button to disable the Touchpad.

Touchpad and Buttons/Mouse

The Touchpad is an alternative to the mouse; however, you can also add a mouse to your computer through one of the USB ports. The Touchpad buttons function in much the same way as a two-button mouse.

Touchpad Sensitivity

The **mouse button zones** at the bottom of the pad measure about **15mm from the bottom** of the pad, and the **left and right buttons** are divided roughly down the middle. Press the left button zone for a left click, and right button zone for a right click action. Note that the Touchpad and Buttons valid operational area is that indicated within the red dotted lines below.



Mouse Driver

If you are using an external mouse your operating system may be able to auto-configure your mouse during its installation or only enable its basic functions. Be sure to check the device's user documentation for details.

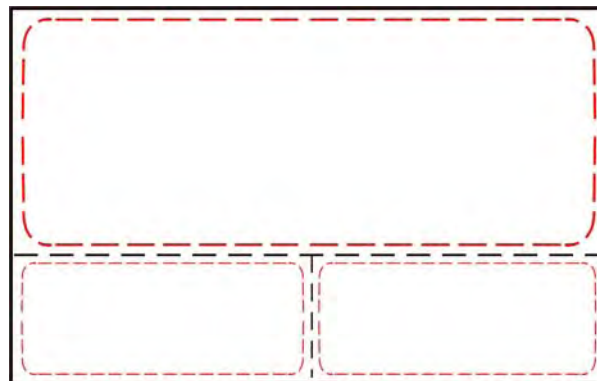

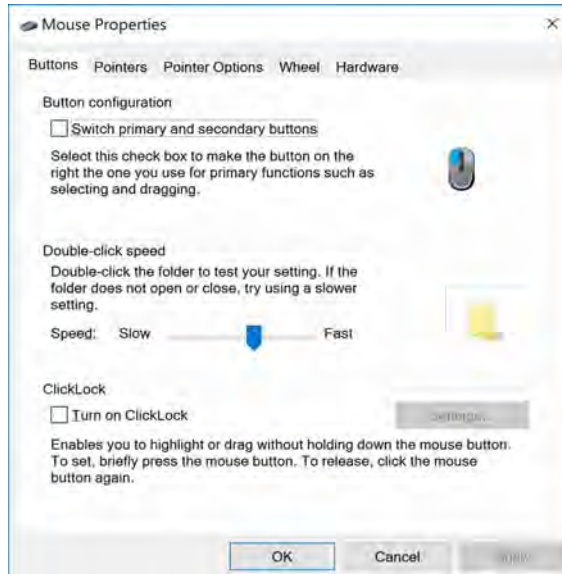

Figure 2 - 2
Touchpad Sensitivity

Mouse Properties Control Panel

You can configure the functions from the **Mouse** control panel in *Windows* as follows.

1. Right-click the **Start Menu**  icon.
2. Select **Control Panel**.
3. Click **Mouse (Hardware and Sound > Devices and Printers)**.
4. Click the menu headings tabs to adjust your mouse preferences.



Disabling the Touchpad

If you need to disable the Touchpad for any reason (e.g. you may find that when using the computer's internal keyboard you accidentally trigger the Touchpad when resting your wrists or palms on it) you can do so by using **Fn + F1** key combination.

Figure 2 - 3
Mouse Properties Control Panel - Buttons

Figure 2 - 4
Mouse Properties Control Panels

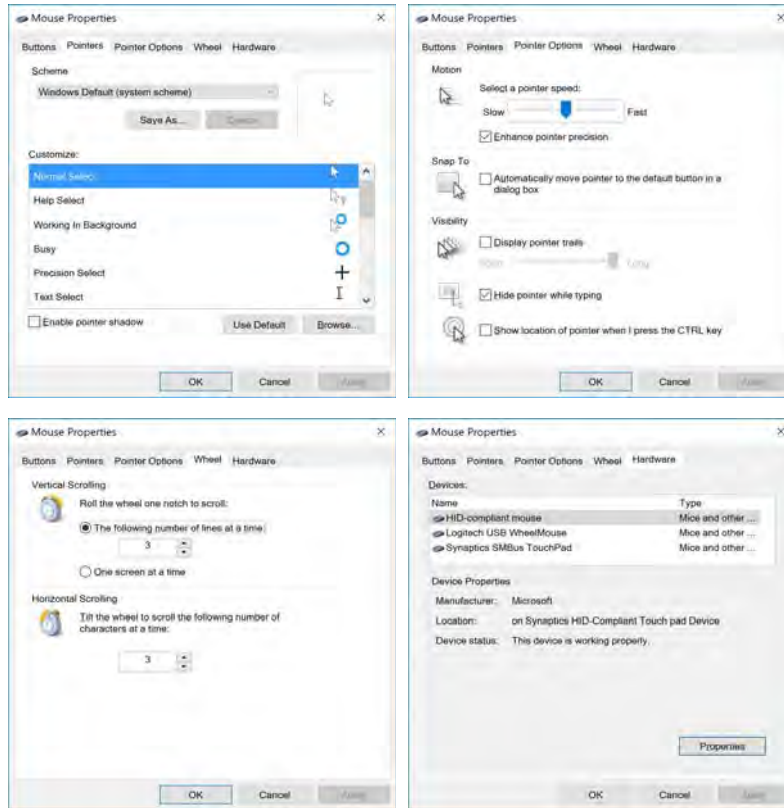

Mouse & Touchpad Devices

You can configure the functions from the **Mouse or Touchpad** control panels in *Devices* in the *Settings* control panel as follows.

1. Click the **Settings** item in the **Start Menu** (or **All Settings** in the Action Center).
2. Click **Devices**.
3. Click **Mouse or Touchpad**.

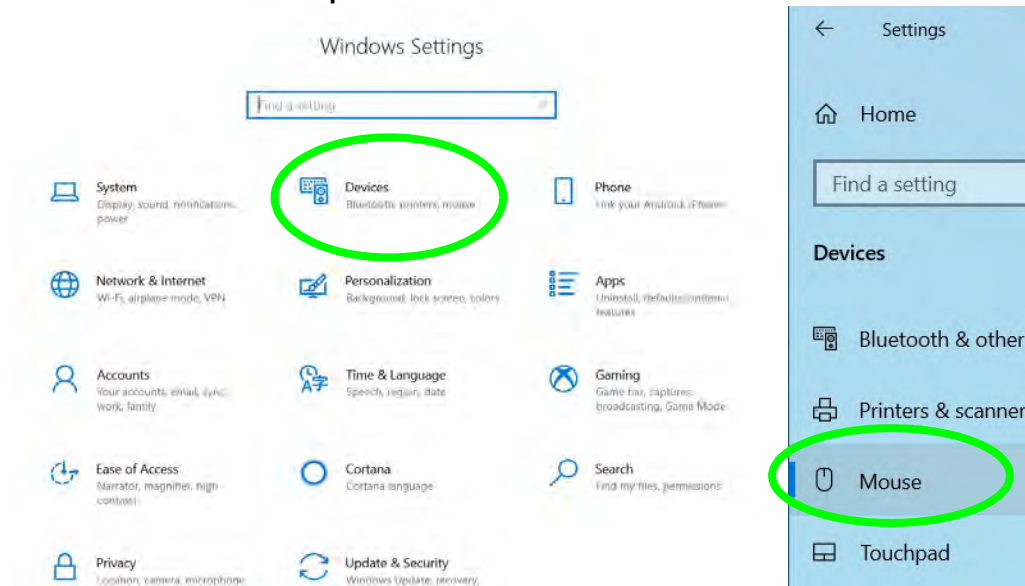

Figure 2 - 5
Windows Settings
> Mouse/Touchpad

Mouse Settings

You can select the primary mouse button and scrolling options and access Mouse Properties from **Additional mouse options**.

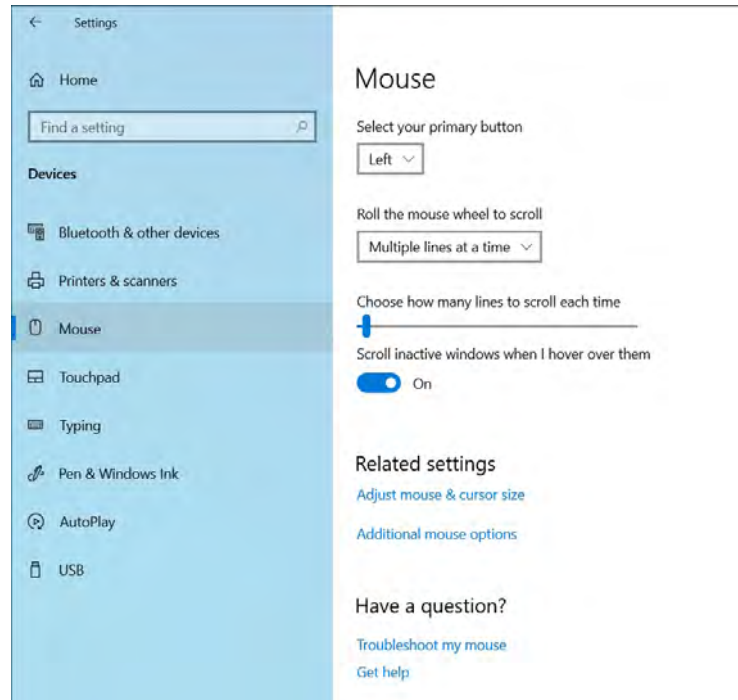

Figure 2 - 6
Windows Settings
Mouse

Touchpad Settings

You can disable the Touchpad by clicking the Touchpad button to turn it off.

You can set the system to automatically disable the internal Touchpad when an external USB point device (e.g a USB mouse) is attached. Click “**Leave touchpad on when a mouse is connected**” to off.

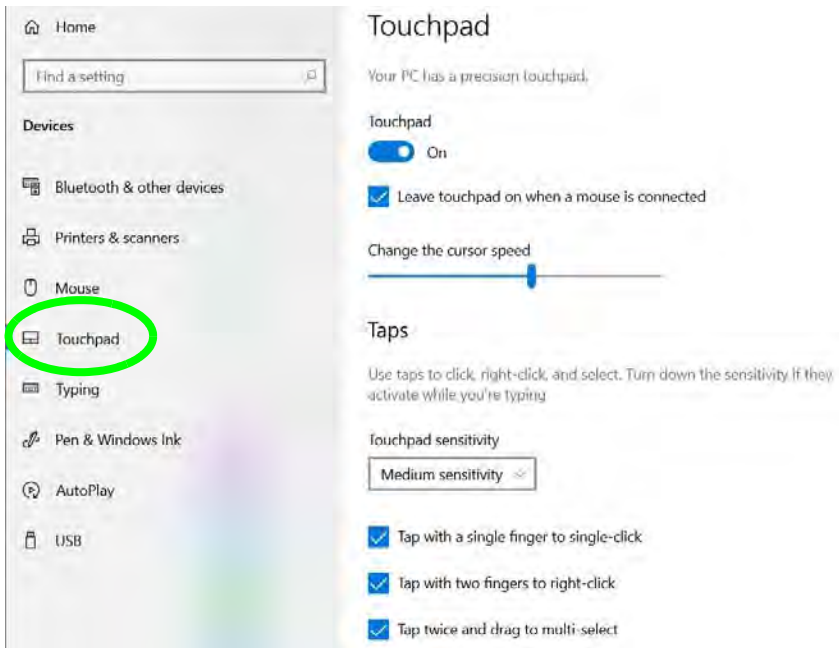

Figure 2 - 7
Windows Settings
Touchpad

Touchpad Taps

The **Touchpad Sensitivity** feature helps prevent recognizing taps on the pad by accident, by recognizing when your palm is resting on it or brushing its surface while you are typing.

Click in the check box to enable/disable the different gestures or taps on the surface of the pad to perform specific actions to manipulate documents, objects and applications.

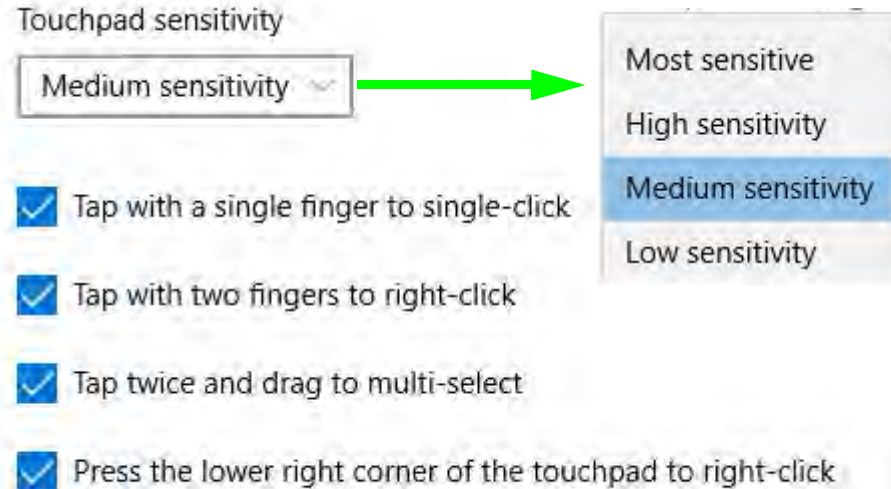

Figure 2 - 8
Windows Settings
Touchpad
Sensitivity & Taps

Touchpad Scroll and Zoom

Click to enable/disable the **two finger scrolling** and **pinch zooming** gesture.



Figure 2 - 9
**Scroll and Zoom/
Scrolling Gesture**

The **two-finger scrolling** feature works in most scrollable windows and allows you to scroll horizontally and vertically. Place two fingers, slightly separated, on the Touchpad surface and slide both fingers in the direction required (in a straight continuous motion).

The **two-finger pinch to zoom** gesture can be used to perform the same function as a scroll wheel in *Windows* applications that support CTRL + scroll wheel zoom functionality. Place two fingers on the pad (for best results use the tips of the fingers) and slide them apart to zoom in, or closer together to zoom out.



Figure 2 - 10
Zooming Gesture

The **three-finger** and **four-finger swipes** and **taps** can be configured for a number of different functions. Select the appropriate function from the drop-down menu.

Figure 2 - 11
Three-Finger Gestures (Swipes & Taps)

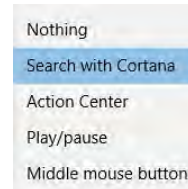
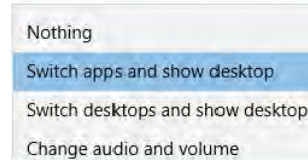
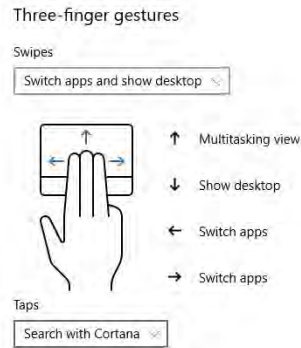
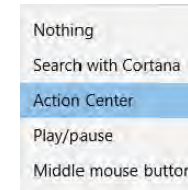
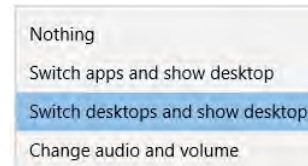
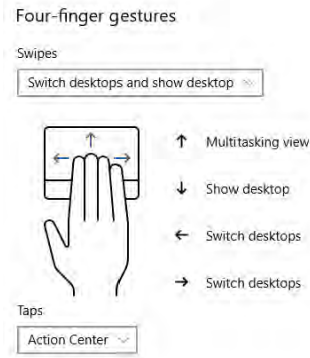

Figure 2 - 12
Four-Finger Gestures (Swipes & Taps)



The following is an overview of some of the main gestures you can use with your Touchpad, however these can be configured from the Touchpad menus.

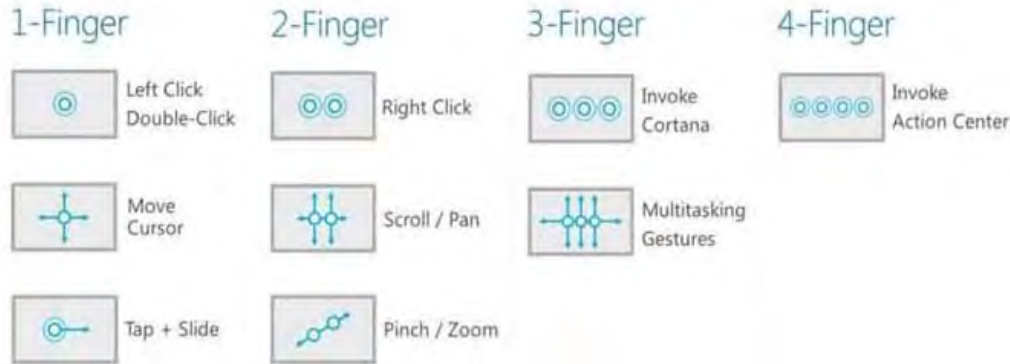

Figure 2 - 13
Touchpad
Gesture Examples



Audio Driver & Creative Sound Blaster Driver

Make sure you install the Audio driver (see page 4 - 11) and then install the Creative Sound Blaster driver (see page 6 - 51) after installing all the system drivers, as this driver is required for audio configuration

If you need to uninstall the audio driver for any reason, and then reinstall it, make sure you reinstall the Creative Sound Blaster driver.

Figure 2 - 14
Realtek Audio Console (Windows Start Menu)

Realtek Audio Console

You can configure the audio options on your computer from the **Sound**  control panel in *Windows*, or from the **Realtek Audio Console Windows Start menu**. **Make sure you have installed the driver and checked the Microsoft Store for updates (see “Audio” on page 4 - 11 and install the Sound Blaster driver (see “Intel® Software Guard Extensions Driver” on page 6 - 32).** The volume may also be adjusted by means of the **volume icon in the taskbar or the audio slider in the Settings menu (see sidebar).**

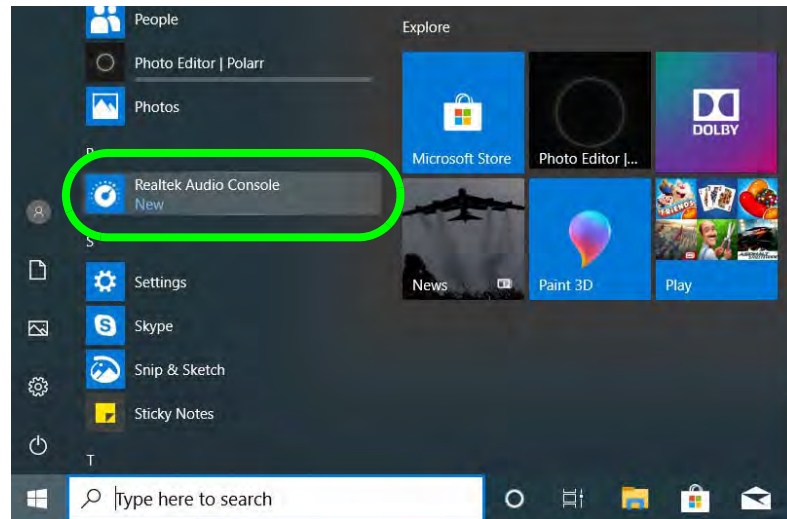

Realtek Audio Console - Main

You can adjust the **Speaker** and **Microphone** levels by using the sliders in the **Realtek Audio Console Main** window.

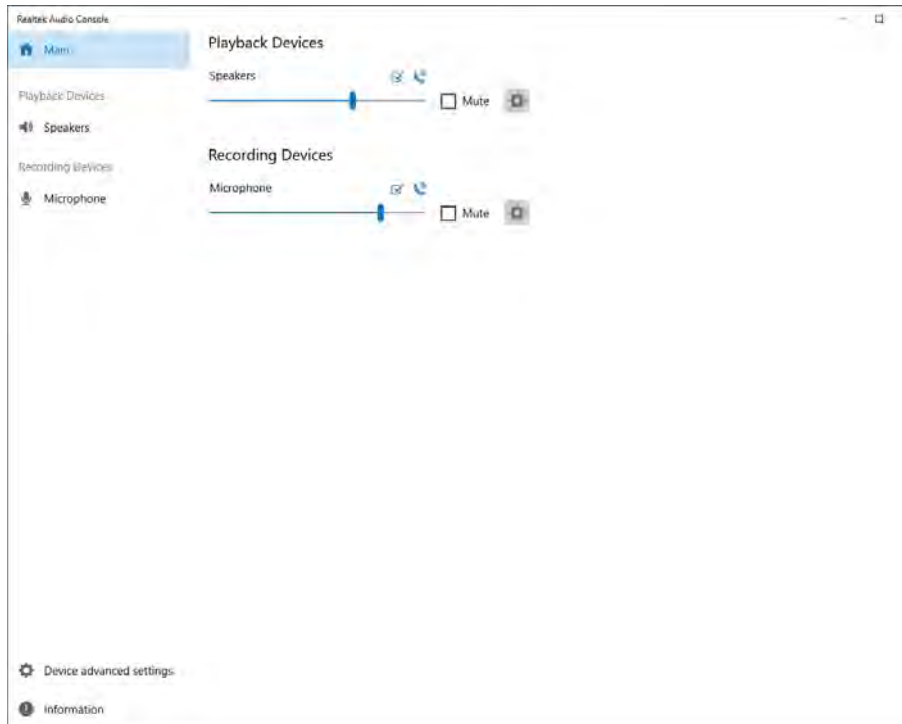

Volume Adjustment

The sound volume level can be clicking using the volume control icon  in the **notification area of the taskbar**.

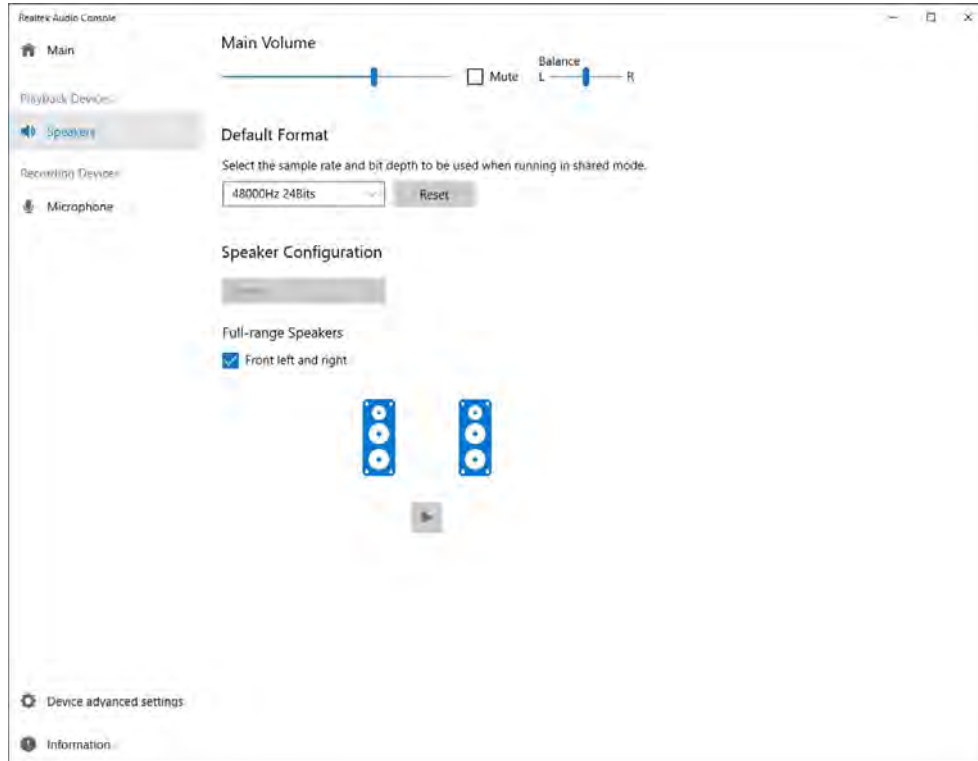

Figure 2 - 15
Realtek Audio Console (Main)

Realtek Audio Console - Speakers

Click **Speakers** to access controls for the format and speaker balance etc.

Figure 2 - 16
Realtek Audio Console (Speakers)



Realtek Audio Console - Microphone

Click **Microphone** to access advanced controls for recording on the microphone. Adjust the recording **Main Volume** level to around **60**, to obtain the optimum recording quality.

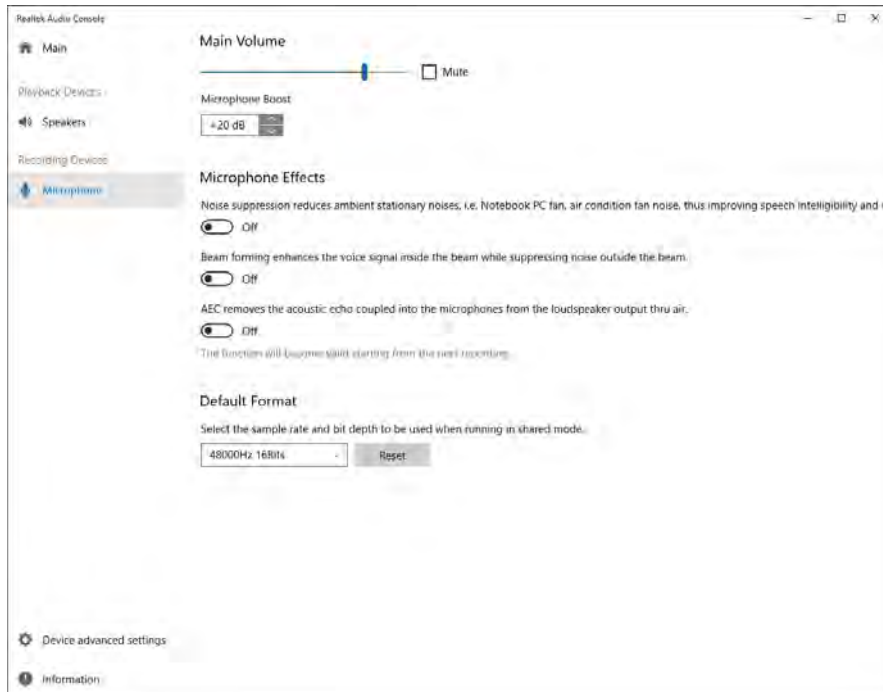

Figure 2 - 17
Realtek Audio Console (Microphone)

Realtek Audio Console - Device Advanced Settings

Device Advanced Settings allows for further configuration of the Connector Settings.

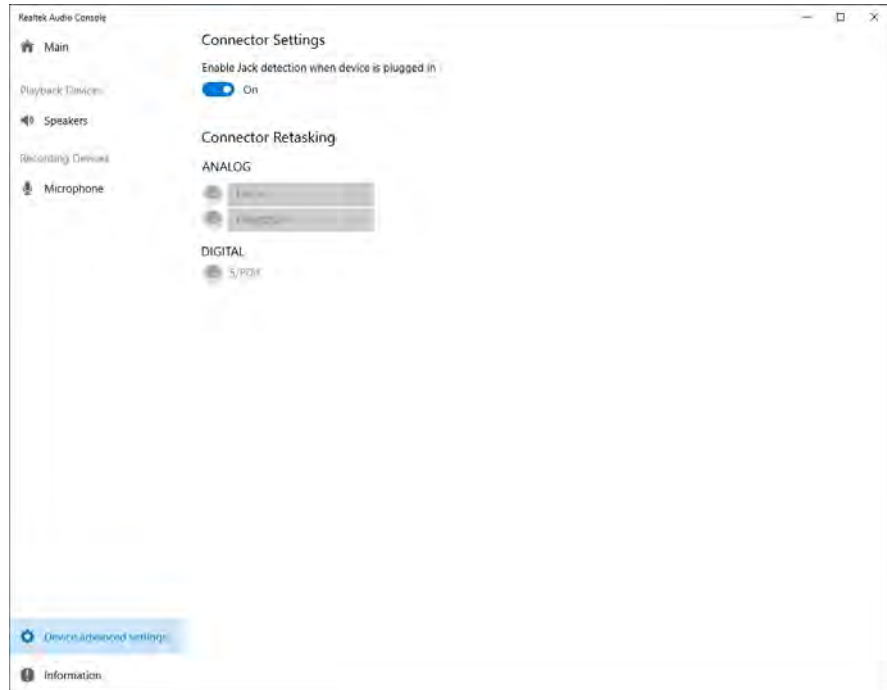

Figure 2 - 18
Realtek Audio Console - Device Advanced Settings

Chapter 3: Power Management

Overview

To conserve power, especially when using the battery, your computer power management conserves power by controlling individual components of the computer (the monitor and hard disk drive) or the whole system. This chapter covers:

- The Power Sources
- Turning On the Computer
- Power Plans
- Power-Saving States
- Configuring the Power Buttons
- Battery Information

The computer uses enhanced power saving techniques to give the operating system (OS) direct control over the power and thermal states of devices and processors. For example, this enables the OS to set devices into low-power states based on user settings and information from applications.



OS Note

Power management functions will vary slightly depending on your operating system. For more information it is best to refer to the user's manual of your operating system.



Forced Off

If the system “hangs”, and the **Ctrl + Alt + Del** key combination doesn’t work, press the power button for **4 seconds**, or longer, to force the system to turn itself off.

The Power Sources

The computer can be powered by either an AC/DC adapter or a battery pack.

AC/DC Adapter

Use only the AC/DC adapter that comes with your computer. The wrong type of AC/DC adapter will damage the computer and its components.

1. **When first setting up the computer use the following procedure** (as to safeguard the computer during shipping, the battery will be locked to not power the system until first connected to the AC/DC adapter and initially set up as below):
 - Attach the AC/DC adapter cord to the DC-In jack at the rear of the computer, then plug the AC power cord into an outlet, and connect the AC power cord to the AC/DC adapter and the battery will now be unlocked.
2. Raise the lid/LCD to a comfortable viewing angle.
3. Press the power button to turn “On”.

Battery

The battery allows you to use your computer while you are on the road or when an electrical outlet is unavailable. Battery life varies depending on the applications and the configuration you're using. **To increase battery life, let the battery discharge completely before recharging** (see *“Battery FAQ” on page 3 - 21*).

We recommend that you do not remove the battery. For more information on the battery, please refer to *“Battery Information” on page 3 - 16*.

Turning On the Computer

Now you are ready to begin using your computer. To turn it on simply press the power button on the front panel.

When the computer is on, you can use the power button as a Stand by/Hibernate/Shutdown hot-key button when it is pressed for less than **4 seconds** (pressing and holding the power button for longer than this will shut the computer down). Use **Power Options (Hardware and Sound)** in the *Windows* control panel to configure this feature.





Power Button as Stand by or Hibernate Button

You can use the OS's "Power Options" control panel to set the power button to send the system into Stand by or Hibernate mode (see your OS's documentation, or "[Configuring the Power Buttons](#)" on page 3 - 9 for details).

Shutting the Computer Down

Note that you should always shut your computer down by choosing the **Shut down** command as this will help prevent hard disk or system problems. Use the **Power**  item in the **Start Menu** and select **Shut down**.

You can also use the **context menu** (right-click the Start Menu  icon or press the Windows logo  + X key combination) to **Sign out**, **Sleep**, **Hibernate**, **Shut down**, and **Restart**.

If you want to add Hibernate/Sleep to the Power Menu see *“Adding Hibernate/Sleep to the Power Menu” on page 3 - 10.*

Figure 3 - 1
Shut Down/Restart

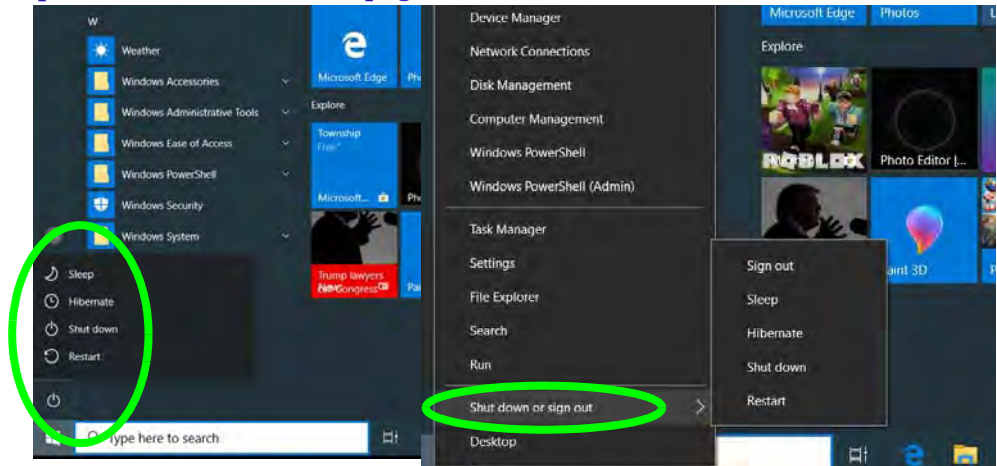



Power Plans

The computer can be configured to conserve power by means of **power plans (Control Panel > Power Options)**. You can use (or modify) an existing **power plan**, or create a new one.

The settings may be adjusted to set the **display** to turn off after a specified time, and to send the computer into **Sleep** after a period of inactivity.

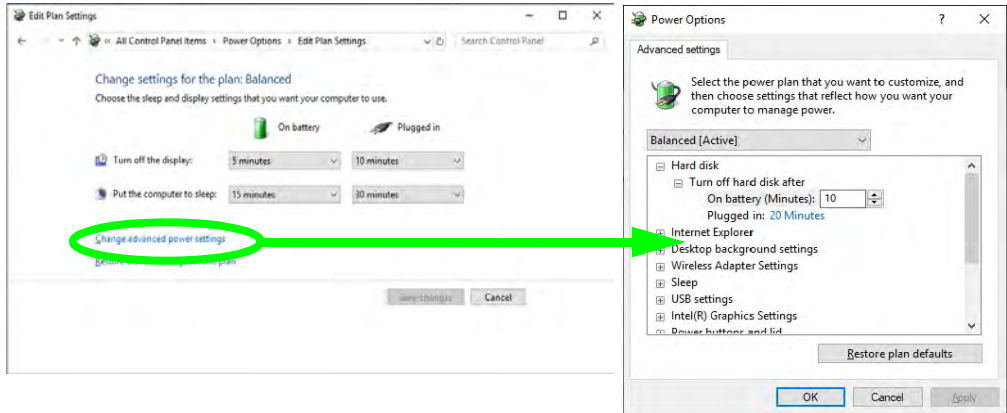
Click *Change plan settings* and then click *Change advanced power settings* to access further configuration options in **Advanced Settings**.





Resuming Operation

See *Table 3 - 1, on page 3 - 11* for information on how to resume from a power-saving state.

Password

It is recommended that you enable a password on system resume in order to protect your data.

Figure 3 - 2
Power Plan Advanced Settings

Power Management

3

Each **Windows power plan** will also adjust the processor performance of your machine in order to save power. This is worth bearing in mind if you are experiencing any reduced performance (especially under DC/battery power).

Choose **High performance** (you may need to click **Show additional plans** to view the High performance plan) for maximum performance when the computer is powered from an AC power source. Choose the **Power saver** (bear in mind that this scheme may slow down the overall performance of the computer in order to save power) for maximum power saving when the computer is battery (DC power) powered.

Figure 3 - 3
Power Plans

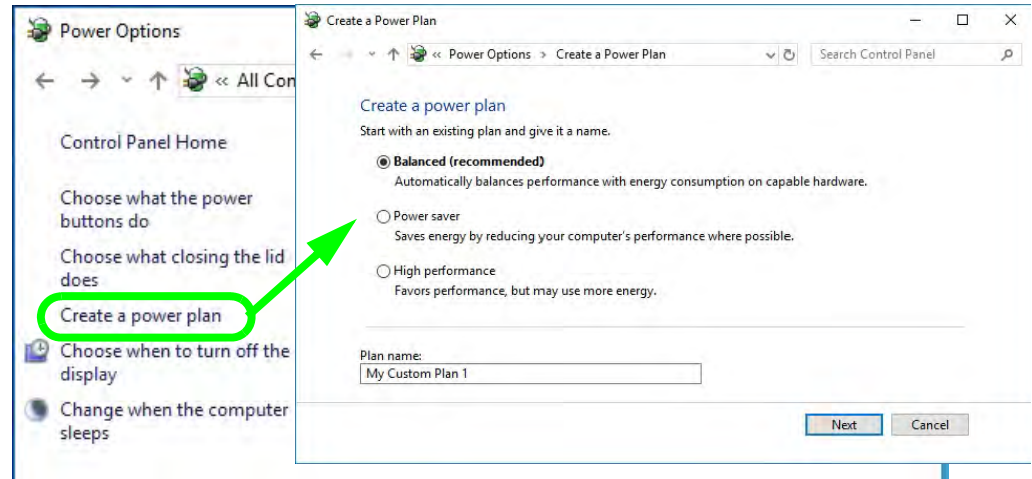

Power-Saving States

You can use power-saving states to stop the computer’s operation and restart where you left off. *Windows 10* uses the **Sleep**, **Hibernate** and **Shut Down** power-saving states.

Sleep

In **Sleep** all of your work, settings and preferences are saved to memory before the system sleeps. When you are not using your computer for a certain length of time, which you specify in the operating system, it will enter **Sleep** to save power.

The PC wakes from **Sleep within seconds** and will return you to where you last left off (what was on your desktop) without reopening the application(s) and file(s) you last used.

If your mobile PC in **Sleep** is running on battery power the system will use only a minimum amount of power. After an extended period the system will save all the information to the hard disk and shut the computer down before the battery becomes depleted.

To add **Sleep** to the **Power Menu** see *“Adding Hibernate/Sleep to the Power Menu” on page 3 - 10.*



Wake On LAN Support

Wake-On-LAN is only supported from **Sleep** or **Hibernate** states in *Windows*.

If you require your computer to wake up from network activity in *Windows* then make sure that the computer is either in **Sleep** or **Hibernate**.

Wake-On-LAN is not supported from **Shut-down** states in *Windows*.

Hibernate

Hibernate uses the least amount of power of all the power-saving states and saves all of your information on a part of the hard disk before it turns the system off. If a power failure occurs the system can restore your work from the hard disk; if a power failure occurs when work is saved only to memory, then the work will be lost. **Hibernate** will also return you to where you last left off within seconds. You should put your mobile PC into **Hibernate** if you will not use the computer for a period of time, and will not have the chance to charge the battery. To add **Hibernate** to the **Power Menu** see *“Adding Hibernate/Sleep to the Power Menu” on page 3 - 10.*

Shut down

You should **Shut down** the computer if you plan to install new hardware, plan to be away from the computer for several days, or you do not need it to wake up and run a scheduled task. Returning to full operation from **Shut down** takes longer than from **Sleep** or **Hibernate**.

Figure 3 - 4
**Power Button &
Start Menu Power**

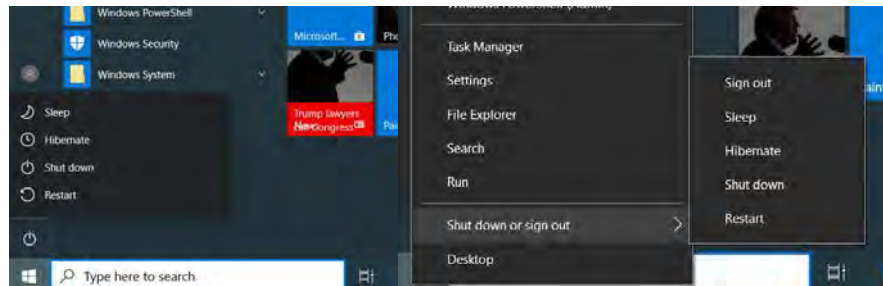

Configuring the Power Buttons

The power/sleep button (Fn + F12 key combo) and closed lid may be set to send the computer in to a power-saving state. Click **Choose what the power buttons do** on the left menu in **Power Options** to bring up the menu.

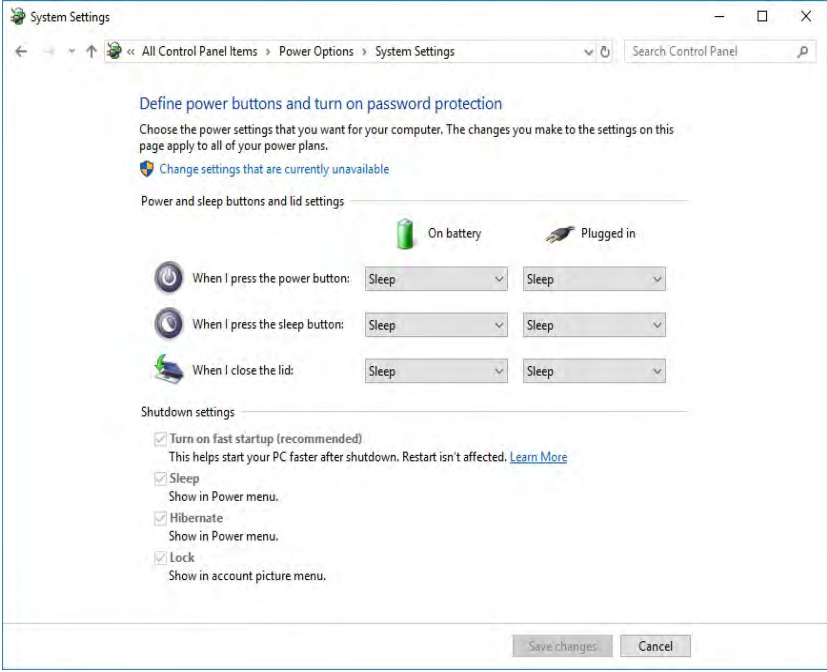



Figure 3 - 5
Power Options
Define Power
Buttons

Adding Hibernate/Sleep to the Power Menu

Add **Hibernate/Sleep** to the **Power Menu** as follows.

1. Go to the **Power Options (Hardware and Sound)** control panel.
2. Click "**Change settings that are currently unavailable**"  Change settings that are currently unavailable .
3. Click **Choose what the power buttons do**.
4. Click to put a check in the **Hibernate/Sleep** box under **Shutdown settings**.
5. Click **Save Changes** and close the control panel.

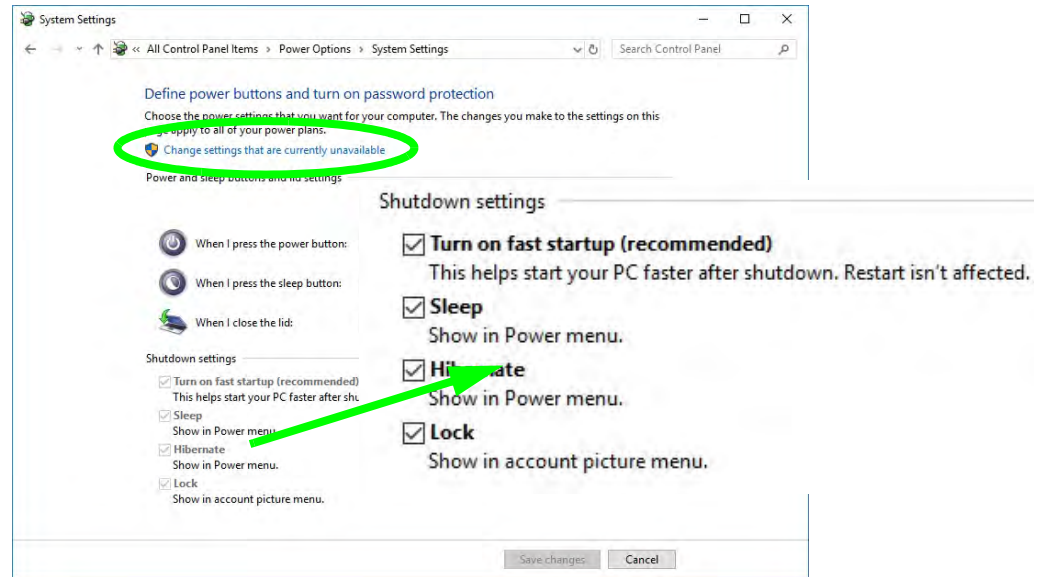

Figure 3 - 6
Power Options
Define Power
Buttons - Shutdown
Settings

Resuming Operation

You can resume operation from power-saving states by pressing the power button, or in some cases pressing the sleep button (**Fn + F12** key combo).



Power Status	Icon  Color	To Resume
Power Off	Off	Press the Power Button
Sleep	Blinking Green	Press the Power Button Press the Sleep Button (Fn + F12 Key Combo)
Hibernate	Off (battery) Orange (AC/DC adapter)	Press the Power Button
Display Turned Off	Green	Press a Key or Move the Mouse/Touchpad

Table 3 - 1
Resuming Operation



Power Button

When the computer is on, you can use the power button as a Sleep/Hibernate/Shut Down hot key button when it is pressed for less than **4 seconds** (pressing and holding the power button for longer than this will force the computer to shut down).



Closing the Lid

If you have chosen to send the computer to **Sleep** when the lid is closed, raising the lid will wake the system up.

Ctrl + Alt + Delete Key Combination

You can use the **CTRL + ALT + DEL** key combination from almost any of the *Windows 10* interfaces/Apps to bring up a full-screen displaying **Lock**, **Switch User**, **Sign out**, **Change a password** and **Task Manager** options. If you click the **Power** icon in the lower right corner of the screen a power management option menu appears to display **Sleep**, **Shut down**, and **Restart**.

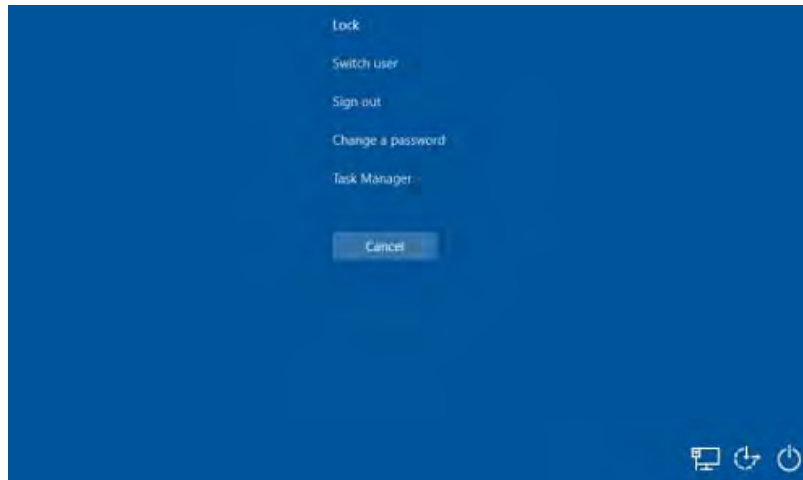

Figure 3 - 7
Ctrl + Alt + Delete
Menu

To fully control all the power options (including Hibernate mode) go to the **Power Options** control panel and configure the power button, sleep button and lid to perform the function selected.

Settings Menu Power Controls

The **Settings** item in the **Start Menu** (or via the **Action Center**) gives you access to a number of power settings control panels which enable you to quickly adjust power options. Click **System** to access the menu including the power option settings.

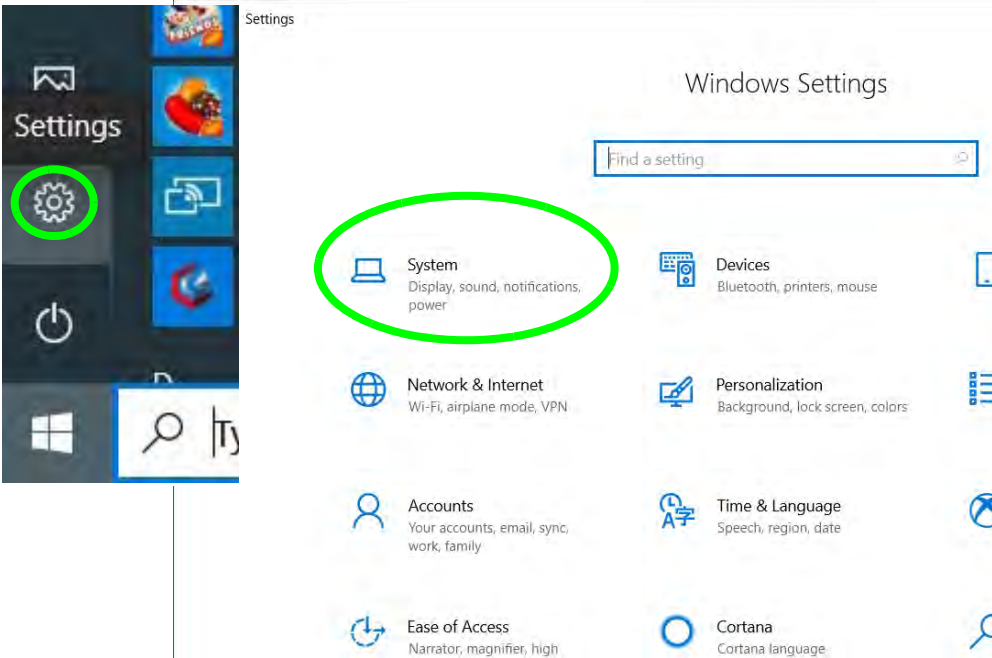

Figure 3 - 8
Settings

Battery Saver

Battery in Settings will display the battery level, and by clicking **Battery usage by app** you can see the current state of battery usage by application etc. The **Battery saver** can be level can be adjusted to be turned on if the battery level falls below a certain level to limit background activity and push notifications.

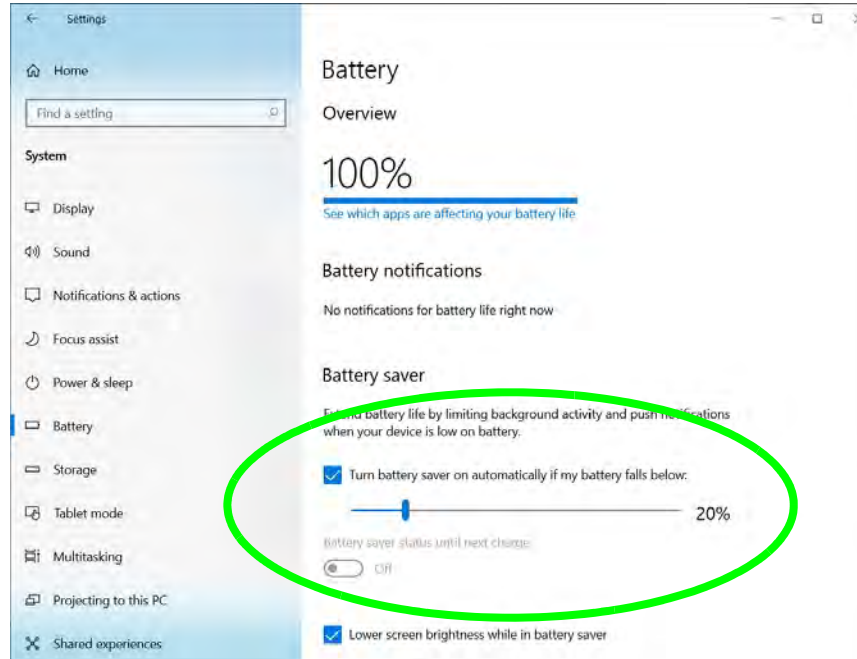

Figure 3 - 10
Settings > Battery >
Battery Saver

Power & Sleep

Power & sleep gives you quick access to **Screen** and **Sleep** settings. Click **Additional power settings** to go to the main power options control panel.

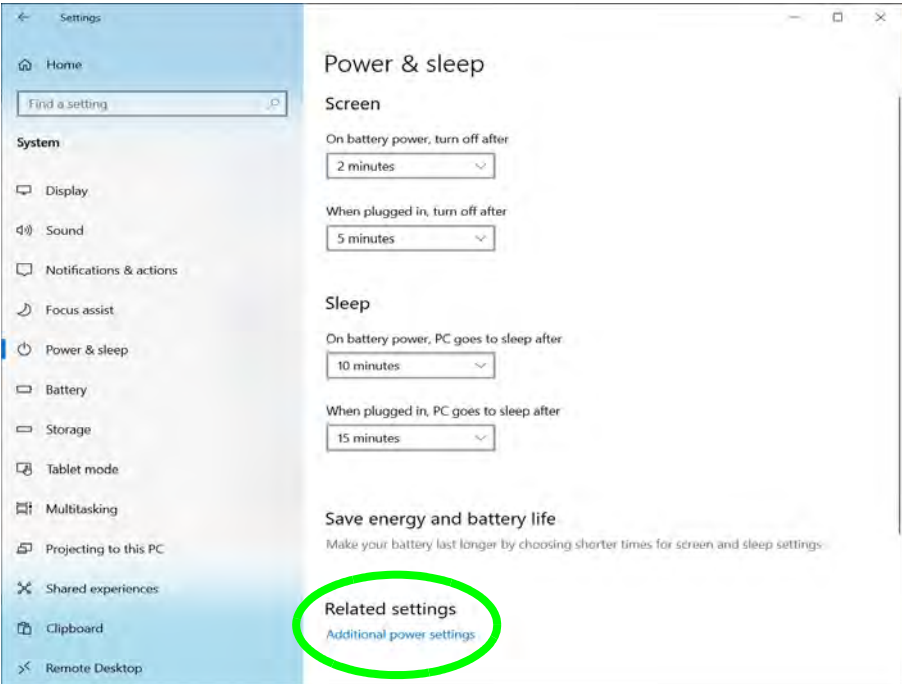

Figure 3 - 11
Settings > Power & Sleep



Low Battery Warning

When the battery is critically low, immediately connect the AC/DC adapter to the computer or save your work, otherwise, the unsaved data will be lost when the power is depleted.

Battery Information

Follow these simple guidelines to get the best use out of your battery.

Battery Power

Your computer's battery power is dependent upon many factors, including the programs you are running, and peripheral devices attached. You can set actions to be taken (e.g. Shut down, Hibernate etc.), and set critical and low battery levels from power plan **Change plan settings > Change advanced power settings** (see [Figure 3 - 3 on page 3 - 6](#)).



Click the battery icon  in the notification area to see the current battery level and charge status (you can also click **Power & sleep settings** to access the **Settings** menu to quickly adjust power settings).

Figure 3 - 12
Battery Icon (Notification Area) & Battery Advanced Settings

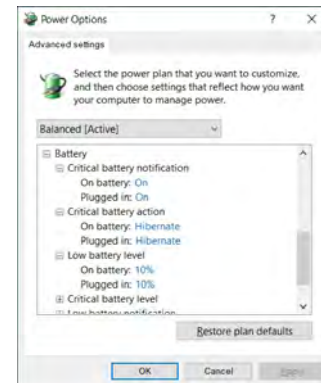
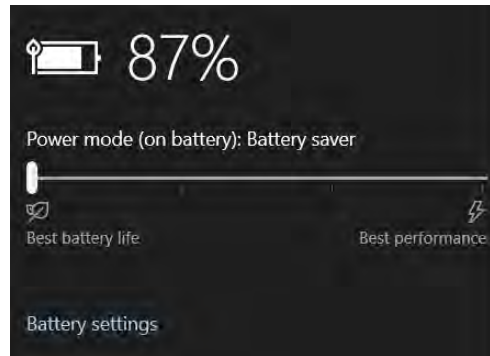
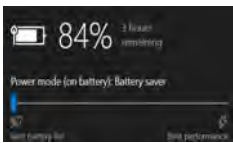
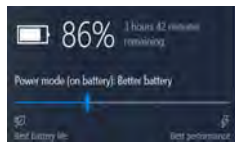
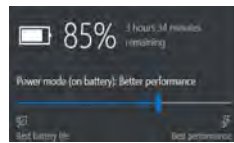
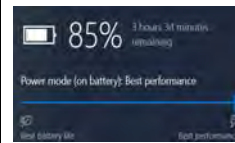

Power Slider Settings

Battery Saver	Better Battery	Better Performance	Best Performance
			
For DC Only	For AC & DC		
Lowest Power Setting	Lower Power than Default Settings	Slightly Favors Performance Over Power	Favors Performance Over Power
Windows Features Throttled & Screen Brightness Reduced	Default Position		
Auto Enabled at 20% of Battery Capacity			



Battery Saver

Note that some Windows features and background applications may behave differently, or may be blocked, when the system is in Battery Saver mode (check with Microsoft for details).

Table 3 - 2
Power Slider Settings & Notes



Windows Mobility Center

The **Windows Mobility Center** control panel (select the **Control Panel** under the **Windows System** item in the **Start Menu**) provides an easy point of access for information on battery status, power plans used and wireless device status etc.

Conserving Battery Power

- Use a **power plan** that conserves power (e.g **Power saver**), however note that this may have an affect on computer performance.
- Lower the brightness level of the LCD display. The system will decrease LCD brightness slightly to save power when it is not powered by the AC/DC adapter.
- Reduce the amount of time before the display is turned off.
- Close wireless, Bluetooth, modem or communication applications when they are not being used.
- Disconnect/remove any unnecessary external devices e.g. USB devices, ExpressCards etc.

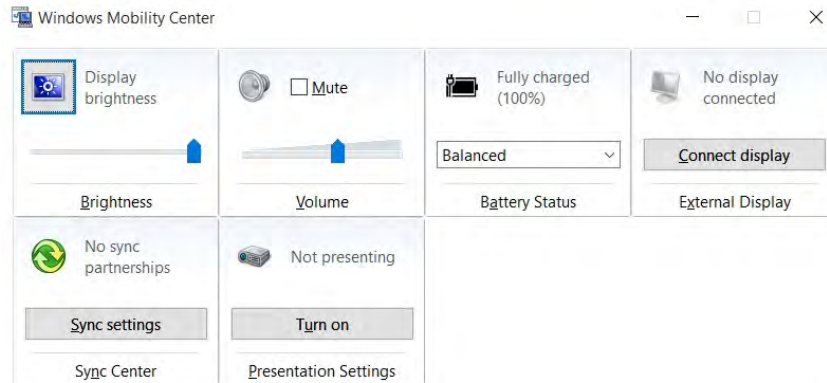

Figure 3 - 13
Windows Mobility Center (Control Panel)

Battery Life

Battery life may be shortened through improper maintenance. **To optimize the life and improve its performance, fully discharge and recharge the battery at least once every 30 days.** We recommend that you do not remove the battery yourself.

Charging The Battery Under Heavy Use

If the computer is being used under a heavy system load (e.g. games or other high-end graphic apps) in battery mode, **try to avoid a cycle of repeatedly plugging and unplugging the adapter to charge the battery.**

Repeatedly plugging and unplugging the adapter may cause inaccuracies in the battery mechanics when displaying battery life and charge, and this may result in a system shutdown despite the battery meter displaying a sufficient remaining charge.

Ideally, if the computer is being used under a heavy system load you should try to use the AC/DC adapter, but if using the battery avoid plugging and unplugging the adapter and allow the battery to fully charge again before switching to battery mode.

New Battery

Always completely discharge, then fully charge, a new battery (see *[“Battery FAQ”](#)* on page 3 - 21 for instructions on how to do this).



Caution

Danger of explosion if battery is incorrectly replaced.

Replace only with the same or equivalent type recommended by the manufacturer. Discard used battery according to the manufacturer's instructions.

Recharging the Battery with the AC/DC Adapter

The battery pack automatically recharges when the AC/DC adapter is attached and plugged into an electrical outlet. If the computer is powered on, and in use, it will take several hours to fully recharge the battery. When the computer is turned off but plugged into an electrical outlet, battery charge time is less. Refer to *“LED Indicators” on page 1 - 10* for information on the battery charge status, and to *“Battery FAQ” on page 3 - 21* for more information on how to maintain and properly recharge the battery pack.

Proper handling of the Battery Pack

- DO NOT disassemble the battery pack under any circumstances
- DO NOT expose the battery to fire or high temperatures, it may explode
- DO NOT connect the metal terminals (+, -) to each other



Damaged Battery Warning

Should you notice any physical defects (e.g. the battery is bent out of shape after being dropped), or any unusual smells emanating from the notebook battery, shut your computer down immediately and contact your distributor/supplier. If the battery has been dropped we do not recommend using it any further, as even if the computer continues to work with a damaged battery in place, it may cause circuit damage, which may possibly result in fire. It is recommended that you replace your computer battery every two years.

Battery FAQ

How do I completely discharge the battery?

Use the computer with battery power until it shuts down due to a low battery. Don't turn off the computer even if a message indicates the battery is critically low, just let the computer use up all of the battery power and shut down on its own.

1. Save and close all files and applications.
2. **Create a power plan** for discharging the battery and set all the options to **Never**.
3. Click **Change plan settings** (after creating it) and click **Change plan settings > Change advanced power settings**.

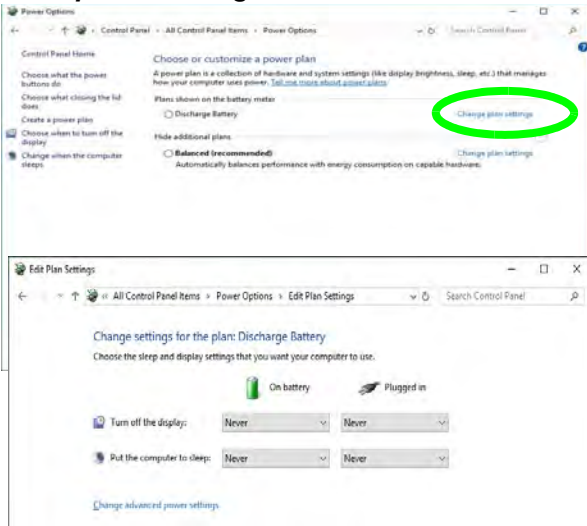

Figure 3 - 14
Change Plan
Settings / Change
Advanced Power
Settings

Power Management

4. Scroll down to **Battery** and click **+** to expand the battery options.
5. Choose the options below (click **Yes** if a warning appears):

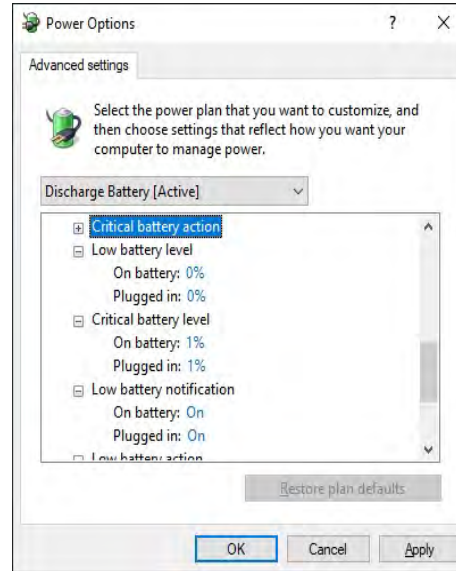

Figure 3 - 15
**Power Options
Advanced Settings -
Battery**

- Low battery level = 0%
- Critical battery level = 1%
- Low battery action = Do Nothing
- Reserve Battery Level = 0%

How do I fully charge the battery?

When charging the battery, don't stop until the LED charging indicator light changes from orange to green.

How do I maintain the battery?

Completely discharge and charge the battery at least once every 30 days or after about 20 partial discharges.

Chapter 4: Drivers & Utilities

This chapter deals with installing the drivers and utilities essential to the operation or improvement of some of the computer's subsystems. The system takes advantage of some newer hardware components for which the latest versions of most available operating systems haven't built in drivers and utilities. Thus, some of the system components won't be auto-configured with an appropriate driver or utility during operating system installation. Instead, you need to manually install some system-required drivers and utilities.

Graphics Mode for Driver Installation

In order to prevent driver installation problems, the system should be in MS Hybrid graphics mode (and the system should Not be in Discrete graphics mode) when installing drivers. When no drivers are installed MS Hybrid mode should be enabled by default.



Driver Installation & Power

When installing drivers make sure your computer is powered by the AC/DC adapter connected to a working power source. Some drivers draw a significant amount of power during the installation procedure, and if the remaining battery capacity is not adequate this may cause the system to shut down and cause system problems (note that there is no safety issue involved here, and the battery will be rechargeable within 1 minute).

What to Install

You will need to attach an external optical CD/DVD device drive to install the drivers from the *Device Drivers & Utilities + User's Manual* disc. The disc contains the drivers and utilities necessary for the proper operation of the computer. *Table 4 - 1, on page 4 - 5* lists what you need to install and it is very important that the drivers are installed by the method outlined in this chapter, and in the order indicated. Note that the information on the following pages is for *Windows 10* (64-bit only).

Module Driver Installation

The procedures for installing drivers for the **Wireless LAN, Bluetooth & WLAN Combo, Intel Technology,** and **Sound Blaster** modules are provided in "*Modules*" on page 6 - 1.

Driver Installation

1. Insert the *Device Drivers & Utilities + User's Manual* disc into an attached DVD drive.
2. Click the message “**Tap to choose what happens with this disc.**”
3. Click **Run autorun.exe**.
4. Click **Install Drivers** (button), or **Option Drivers** (button) to access the **Optional** driver menu.



Figure 4 - 1 - Drivers Installer Screen 1

Drivers & Utilities

5. Check the driver installation order from **Table 4 - 1, on page 4 - 5** (the drivers must be installed in this order) which is the same as that listed in the *Drivers Installer* menu below.
6. Click to select the driver you wish to install, (you should note down the drivers as you install them).
7. Follow the instructions for each individual driver installation procedure as listed on the following pages.



Figure 4 - 2 - Install Drivers

Win 10 (64-bit) Driver	Page #	Win 10 (64-bit) - Optional Items	Page #
<i>Chipset</i>	<i>Page 4 - 8</i>	<i>SATA Mode Setup (Optane™, RAID or AHCI)</i>	<i>Page 6 - 2</i>
<i>Serial IO</i>	<i>Page 4 - 8</i>	<i>Wireless LAN Module</i>	<i>Page 6 - 14</i>
<i>Intel Video (VGA)</i>	<i>Page 4 - 8</i>	<i>Fingerprint Reader Module</i>	<i>Page 6 - 20</i>
<i>NVIDIA Video (VGA)</i>	<i>Page 4 - 9</i>	<i>Bluetooth & WLAN Combo Module</i>	<i>Page 6 - 24</i>
<i>LAN</i>	<i>Page 4 - 9</i>	<i>Thunderbolt Port Driver</i>	<i>Page 6 - 24</i>
<i>Card Reader</i>	<i>Page 4 - 9</i>	<i>Intel® Software Guard Extensions Driver</i>	<i>Page 6 - 32</i>
<i>Control Center</i>	<i>Page 4 - 10</i>	<i>Intel® Rapid Storage Technology</i>	<i>Page 6 - 33</i>
<i>MEI Driver</i>	<i>Page 4 - 10</i>	<i>PC Camera</i> (no driver installation required)	<i>Page 6 - 61</i>
<i>Intel® HID Filter Driver</i>	<i>Page 4 - 9</i>	<i>Trusted Platform Module</i> (no driver installation required)	<i>Page 6 - 68</i>
<i>Intel® Dynamic Platform Driver</i>	<i>Page 4 - 10</i>	<i>All drivers provided are for the Windows 10 (64-bit) operating system. Note that you need to install both the WLAN & Bluetooth drivers for the WLAN & Bluetooth Combo modules.</i>	
<i>Creative Sound Blaster Atlas Audio</i>	<i>Page 4 - 10 & Page 6 - 32</i>		
<i>Audio</i>	<i>Page 4 - 11</i>		

Table 4 - 1 - Driver Installation

Manual Driver Installation

Click **Browse CD/DVD** (button) in the *Drivers Installer* application and browse to the executable file in the appropriate driver folder.

4

Latest Updates

After installing all the drivers make sure you enable Check for updates (**Settings > Update & security > Check for updates**) and go to the **Microsoft Store** and click **Downloads and updates > Get updates** to update all Apps etc. See *“Windows Update” on page 4 - 12* for instructions.

Updating/Reinstalling Individual Drivers

If you wish to update/reinstall individual drivers it may be necessary to uninstall the original driver. To do this go to the **Control Panel** in the *Windows OS* and double-click the **Programs** icon (**Programs > Uninstall a program**). Click to select the driver (if it is not listed see below) and click **Uninstall**, and then follow the on screen prompts (it may be necessary to restart the computer). Reinstall the driver as outlined in this chapter.

If the driver is not listed in the **Programs and Features** menu:

1. Go to the **Control Panel**).
2. Double-click **Device Manager (Hardware and Sound > Devices and Printers > Device Manager)**.
3. Double-click the **device** you wish to update/reinstall the driver for (you may need to click “+” to expand the selection).
4. Click **Driver** (tab) and click the **Update Driver** or **Uninstall** button and follow the on screen prompts.

User Account Control

If a **User Account Control** prompt appears as part of the driver installation procedure, click **Continue** or **Allow**, and follow the installation procedure as directed.

Windows Security Message

If you receive a *Windows* security message as part of the driver installation process. Just click “*Install this driver software anyway*” or “*Install*” to continue the installation procedure.

You will receive this message in cases where the driver has been released after the version of *Windows* you are currently using. All the drivers provided will have already received certification for *Windows*.

New Hardware Found

If you see the message “**New Hardware Found**” during the installation procedure (**other than when outlined in the driver install procedure**), click **Cancel** to close the window, and follow the installation procedure.



Driver Installation General Guidelines

The driver installation procedure outlined in this Chapter (and in **Chapter 7 Options & Modules**), are accurate at the time of going to press.

Drivers are always subject to upgrade and revision so the exact procedure for certain drivers may differ slightly. As a general guide follow the default on screen instructions for each driver (e.g. **Next > Next > Finish**) unless you are an advanced user. In many cases a restart is required to install the driver.

Make sure any modules (e.g. WLAN or Bluetooth) are **ON (i.e. the system is not in Airplane Mode)** before installing the appropriate driver.

Driver Installation Procedure

Insert the *Device Drivers & Utilities + User's Manual disc* and click **Install Drivers** (button). *Note the system should be in MS Hybrid mode before installing drivers.*

4

Chipset



Note: During the driver installation process the screen resolution may change. Make sure you restart after the driver installation process, as instructed, in order to restore the original resolution.

1. Click **1.Install Chipset Driver > Yes**.
2. Click **Next > Accept > Install**.
3. Click **Restart Now** to restart the computer.

Serial IO

1. Click **2.Serial IO Driver > Yes**.
2. Click **Next**.
3. Click the check box to accept the license and then click **Next > Next > Next**.
4. Click **Finish** to restart the computer.

Intel Video (VGA)

1. Click **3.Install Intel VGA Driver > Yes**.
2. Click **Next > Yes > Next > Next**.
3. Click **Finish** to restart the computer.
4. **Intel Graphics Command Center** will download but you will need to have a working internet connection.
5. Click the **Start** menu in Windows to access the **Microsoft Store** app tile under **Explore**.
6. Click the **Sign in** icon  and select **Downloads and updates**.
7. Click **Check for Updates**.
8. A list of apps being downloaded will pop-up.
9. To prioritize the Realtek audio driver you can click **Pause all** to pause the download queue.
10. Click on **Intel Graphics Command Center** and click on the resume icon  to download the driver.
11. When finished the **Intel Graphics Command Center** will appear in the **Windows Start** menu.

NVIDIA Video (VGA)

1. Click **4.Install NVIDIA VGA Driver > Yes**.
2. Click **AGREE AND CONTINUE** (button) to accept the terms of the license agreement.
3. Click **NEXT**.
4. Click **Close** to complete the installation.
5. Go to the Microsoft Store to download the NVIDIA Control Panel.
6. After all the drivers have been installed (an internet connection is required) run the **NVIDIA GeForce Experience** by clicking the desktop icon  (or App).

Note: After installing the video driver go to the **Display** control panel to adjust the video settings to the highest resolution.

LAN

*Note: If the computer enters a deep sleep mode during installation, you will be prompted to plug in a network cable, and click **OK**, to continue installation. If a network cable is not available, restart the system and re-install the LAN driver.*

1. Click **5.Install LAN Driver > Yes**.
2. Click **Next > Install**.
3. Click **Finish**.

Card Reader

1. Click **6.Install Cardreader Driver > Yes**.
2. Click **Finish**.

Intel® HID Filter Driver

1. Click **7.Install HID Filter Driver > Yes**.
2. Click **Next**.
3. Click **Yes** to accept the terms of the license agreement.
4. Click **Next**.
5. Click **Finish** to restart the computer.

Control Center

1. Click **8.Install Ctrl Center Driver > Yes**.
2. Click **Next > Install**.
3. Click **Finish > Finish** restart the computer (see *Appendix B*).



MEI Driver

1. Click **9.Install MEI Driver > Yes**.
2. Click **Next**.
3. Click the check box to accept the terms of the license agreement and then click **Next**.
4. Click **Next**.
5. Click **Finish**.



Intel® Dynamic Platform Driver

1. Click **10.Install DPTF Driver > Yes**.
2. Click **OK > OK** to complete the installation (make sure you click both OK prompts).

Creative Sound Blaster Atlas Audio

1. Click **11.Install Creative Driver > Yes**.
2. Click **OK** to restart the computer.
3. **Sound Blaster Atlas** App will download but you will need to have a working internet connection.
4. Click the **Start** menu in Windows to access the **Microsoft Store App** tile under **Explore**.
5. Click the **Sign in** icon  and select **Downloads and updates**.
6. Click **Check for Updates**.
7. A list of apps being downloaded will pop-up.
8. To prioritize the **Sound Blaster Atlas** driver you can click **Pause all** to pause the download queue.
9. Click on **Sound Blaster Atlas** and click on the resume icon  to download the driver.
10. When just installed the **Sound Blaster Atlas** will appear in the **Windows Start** menu.

Audio

1. Click **13.Install Audio Driver > Yes**.
2. Click **Next**.
3. Click **Finish** to restart the computer.
4. **Realtek Audio Control Panel** will download but you will need to have a working internet connection.
5. Click the **Start** menu in Windows to access the **Microsoft Store App** tile under **Explore**.
6. Click the **Sign in** icon  and select **Downloads and updates**.
7. Click **Check for Updates**.
8. A list of apps being downloaded will pop-up.
9. To prioritize the Realtek audio driver you can click **Pause all** to pause the download queue.
10. Click on **Realtek Audio Console** and click on the resume icon  to download the driver.
11. When installed the **Realtek Audio Console** will appear in the **Windows Start** menu.

After installing the audio driver the system will not return to the **Drivers Installer** screen. To install the optional drivers, eject the *Device Drivers & Utilities + User's Manual* disc and then reinsert it (or double-click the disc icon in My Computer), and click **Option Drivers** (button) to access the optional driver menu.

It is recommended that you install the **Intel Rapid Storage Technology** driver (see “*Intel® Rapid Storage Technology*” on page 6 - 33 - required for AHCI, Optane & RAID mode).



Windows Update

After installing all the drivers make sure you enable **Windows Update** in order to get all the latest security updates etc. (all updates will include the latest **hotfixes** from Microsoft).

To enable **Windows Update** make sure you are **connected to the internet**:

1. Go to the **Control Panel**.
2. Click **Windows Update** (System and Security/ Security).
3. Click **Check for updates** (button).
4. The computer will now check for updates (you need to be connected to the internet).
5. Click **Install now** (button) to begin checking for the updates.
6. Click **Install updates** (button) to install the updates.

Optional Drivers

See the pages indicated in *Table 4 - 1, on page 4 - 5* for the driver installation procedures for any modules included in your purchase option.

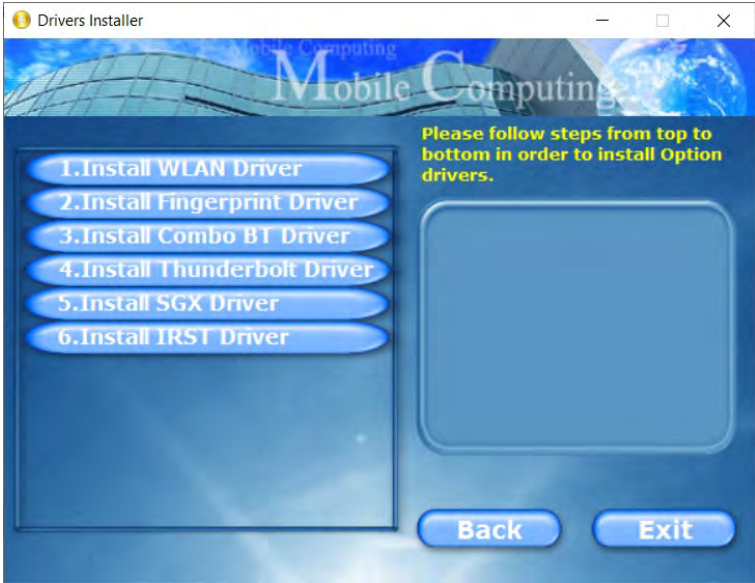

Figure 4 - 3 - Optional Drivers Installer Screen

Note that you need to install both the WLAN & Bluetooth drivers for the WLAN & Bluetooth Combo modules.

Chapter 5: BIOS Utilities

Overview

This chapter gives a brief introduction to the computer's built-in software **BIOS** (Basic Input/Output System).

If your computer has never been set up, or you are making important changes to the system (e.g. hard disk setup), then you should review this chapter first and note the original settings found in **BIOS**. Even if you are a beginner, keep a record of the settings you find and any changes you make. This information could be useful if your system ever needs servicing.

There is one general rule: *Don't make any changes unless you are sure of what you are doing*. Many of the settings are required by the system, and changing them could cause it to become unstable or worse. If you have any doubts, consult your service representative.

To enter *BIOS*, turn on the computer and press F2 as the system “Boots up”.



BIOS Screens

Note that the BIOS screens pictured on these pages are intended for guidance in setting up your system's BIOS.

BIOS versions are subject to constant change and revision, therefore your computer's actual screens may appear slightly different from those pictured on these pages.



BIOS Settings Warning

Incorrect settings can cause your system to malfunction. To correct mistakes, return to *BIOS* and **Load Optimized Defaults** (press F9).



BIOS Menus

The menus shown in this section are for **reference** only. Your computer's menus will indicate the configuration appropriate for your model and options.

The Insyde BIOS Utility

Each time you turn on the computer the system takes a few seconds to conduct a including a quick test of the on-board RAM (memory).

As the boot process proceeds, the computer will tell you if there is anything wrong. If there is a problem that prevents the system from booting, it will display a system summary and prompt you to run the BIOS setup.

If there are no problems the system will load the operating system. Once that starts, you can't get into **BIOS** without rebooting.

The **Setup BIOS Utility** tells the system how to configure itself by translating instructions from the operating system, and other software, into instructions that the computer hardware understands. manage basic features, identify installed devices and subsystems (e.g. port configuration).



BIOS and Resuming From Hibernation

When the system **resumes from Hibernation** the option will be available to press F2 to enter the BIOS. **In this case do not make any changes to the BIOS settings** as this may result in system errors.

If you wish to change the BIOS settings, restart the system and press F2 to enter the BIOS to make and save any changes required.

Updating the BIOS / CPU

If you need to update the BIOS please contact your distributor or supplier to obtain the latest version.

After using the utility to update the BIOS (or if the CPU has been changed) you will need to **press F2 at Boot** to enter the BIOS, and then **press F9 to load the BIOS defaults**, and then **press F10 to save and exit** the settings.

After the system restarts you should press **F2** to enter the BIOS again and reset the BIOS settings to your preferences, and then save the final settings.

UEFI Boot

UEFI (Unified Extensible Firmware Interface) is an advanced firmware standard supporting fast startup.

With UEFI Boot prompts at boot to press **F2** (to access the BIOS) or **F7** (to access Boot options) will not appear. However you can still press **F2** to enter the setup, or **F7** to choose the preferred boot device, if you press the key immediately the system boots up.

To enter *BIOS*, turn on the computer and press F2 as the system “Boots up”.

If the computer is already on, reboot using the **Ctrl + Alt + Delete** combination and then hold down **F2** when prompted. The *BIOS* main menu will appear. To see the boot options press **F7** and choose your preferred boot device.

Insyde BIOS Start Screen

On accessing the BIOS you will be presented with the Start Screen with 5 menu icons, date and time information, CPU temperature information and navigation and Help icons at the bottom of the screen.

You can use the Touchpad, an attached mouse, or the cursor/arrow keys to navigate the menus and press *Enter* to access the submenu.



Figure 5 - 1
Insyde BIOS Start Screen

Insyde BIOS Start Screen Options:

- **Continue:** Press *Enter* here or click *Continue* to carry on with the boot process and load the operating system.
- **Boot Manager:** Press *Enter* here or click *Boot Manager* to access the Boot Manager utility.
- **Boot From File:** Press *Enter* here or click *Boot From File* to select a file or device to Boot from.
- **Administer Secure Boot:** Press *Enter* here or click *Administer Secure Boot* to proceed with a Secure Boot process. This will take you to the Secure Boot screen which allows you to manage secure boot settings.
- **Setup Utility:** Press *Enter* here or click *Setup Utility* to access the BIOS settings in the Setup Utility.

Note to return to the Start Screen from any of the submenus press the *Esc* key.

Boot Manager

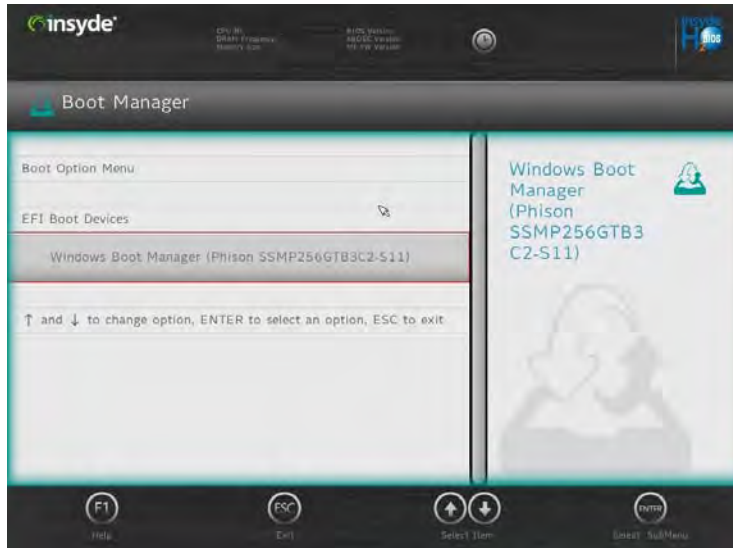

Figure 5 - 2
Boot Manager

When you turn the computer on it will look for an operating system from the devices listed in this menu, and **in this priority order**. If it cannot find the operating system on that device, it will try to load it from the next device in the order specified in the **Boot Option Menu**.

Press Enter to access the menu, use the arrow keys to move up and down the menu, and press Enter to select a device.



BIOS Screens

Note that the BIOS screens pictured on these pages are intended for guidance in setting up your system's BIOS.

BIOS versions are subject to constant change and revision, therefore your computer's actual screens may appear slightly different from those pictured on these pages.

Boot From File / File Explorer

Figure 5 - 3
Boot From File
(File Explorer)

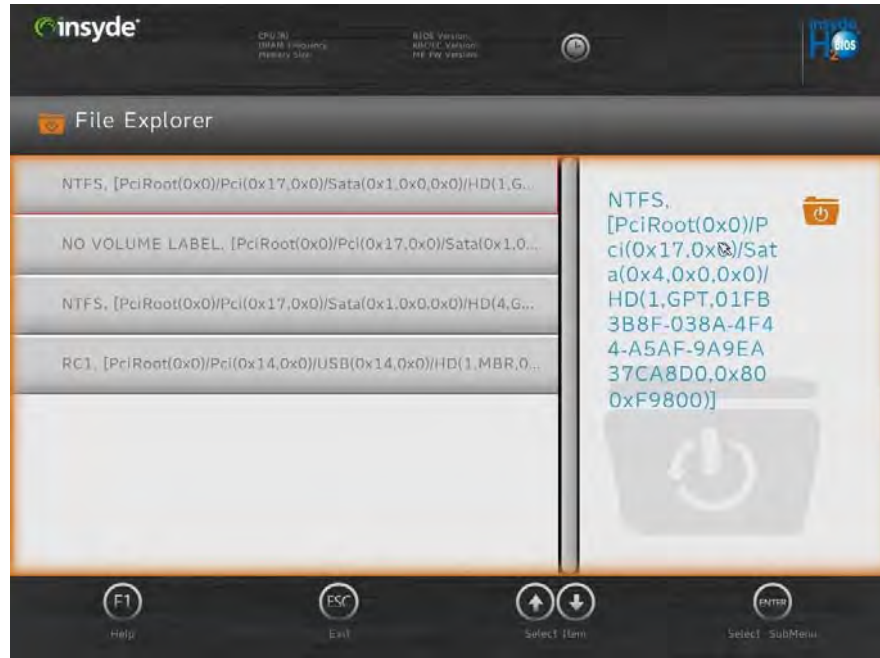

If you need to boot from a file (e.g. on a USB flash drive) then access this menu and use the cursor keys to select the device or file (you can press *Enter* to explore for a file on an attached device).

Administer Secure Boot

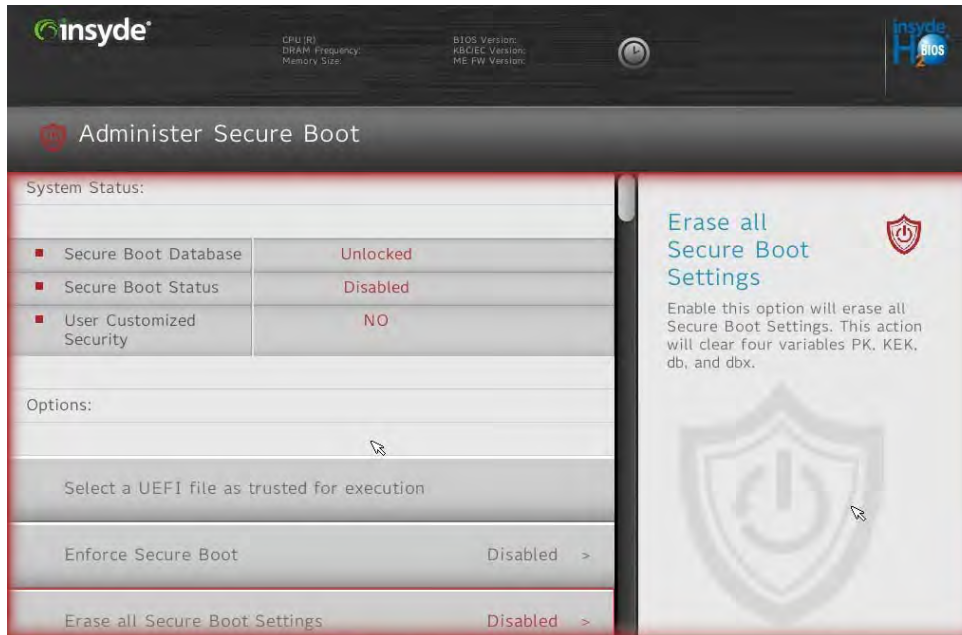

Figure 5 - 4
Administer Secure Boot

5

Secure Boot prevents unauthorized operating systems and software from loading during the startup process. You can select a trusted UEFI file to execute the BIOS, make sure that you Enforce Secure Boot, Erase all Secure Boot Settings or Restore the Factory Settings.

You can also make custom changes to the Key Management database if required by accessing the advanced secure boot options for Platform Key (PK Options), Key Exchange Key (KEK Options), Allowed Signatures Database (DB Options) and Forbidden Signatures Database (DBX Options).

5

Figure 5 - 5
Administer Secure Boot (Advanced Secure Boot Options)



Setup Utility - Main Menu



Figure 5 - 6
Main (Upper)

SATA Port # (Main Menu)

Pressing **Enter** opens the sub-menu to show the configuration of an SSD on the computer's SATA Ports.

OffBoard SATA/NVme Controller Configuration (Main Menu)

Pressing **Enter** opens the sub-menu to show the configuration of any devices on the off board SATA/NVme Controller if applicable.

System Time & System Date (Main Menu)

The hour setting uses the 24-hour system (i.e., 00 = midnight; 13 = 1 pm). If you can change the date and time settings in your operating system, you will also change these settings. Some applications may also alter data files to reflect these changes.

System/Extended Memory: (Main Menu)

This item contains information on the system memory, and is not user configurable. The system will auto detect the amount of memory installed.

MB Series / BIOS Revision / KBC/EC firmware Revision / MAC Address

This item contains information on the BIOS version, network adapter address etc., and is not user configurable.

Figure 5 - 7
Main (Lower)



ME FW Version:	
System Memory:	640KB
Extended Memory:	4096 MB (DDR4)
MB Series:	
BIOS Version:	
KBC/EC Firmware Revision:	
MAC Address:	

Setup Utility - Advanced Menu



5

Figure 5 - 8
Advanced Menu

Advanced Chipset Control (Advanced Menu)

The sub-menu here allows you to enable/disable **Flexicharger**, **VT-d**, **UEFI OS Fast Boot**, and **Software Guard Extensions**.



FlexiCharger Warning

If you leave the FlexiCharger continuously "Enabled" for a period of three months or more, the battery meter's reading accuracy will deteriorate.

To reset this, set the FlexiCharger to "Disabled", and then allow the battery to completely discharge (see "[Battery FAQ](#)" on page 3 - 21) before enabling the function again.

FlexiCharger Enable (Advanced Menu > Advanced Chipset Control)

The sub-menu here allows you to enable/disable the **FlexiCharger**. The FlexiCharger may be set to automatically start charging your battery when the battery reaches a certain capacity level (e.g. you could start the battery charge level at 40%).

You can then set the level to stop charging (e.g. 100%), and of course this stop charge level must be higher than the start charge level.

See the sidebar warning for information on running the FlexiCharger for an extended period as this is not recommended.

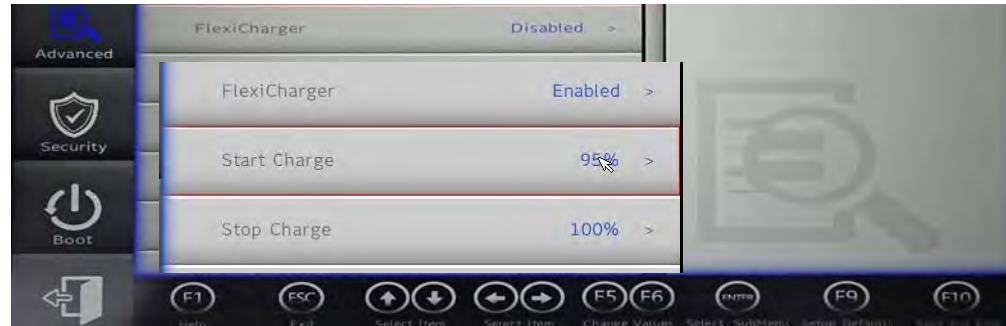

Figure 5 - 9
**Advanced Chipset
Control >
FlexiCharger**

VT-d (Advanced Menu > Advanced Chipset Control)

Enable/disable **Intel® Virtualization Technology for Directed I/O (VT-d)** from this menu. This extends Intel's Virtualization Technology (VT) by providing hardware assists for a virtualization solution.

UEFI OS Fast Boot(Advanced Menu > Advanced Chipset Control)

Use this menu item to enable/disable the Fast Boot option, which when enabled, helps reduce the time it takes to boot the computer.

Software Guard Extensions (SGX) - (Advanced Menu > Advanced Chipset Control)

Intel provides SGX, which is a set of instructions allowing user-level code a degree of security, and privacy, from the operating system. Make sure that SW Guard Extensions is **Enabled** here, and then install the driver (see *“Intel® Software Guard Extensions Driver” on page 6 - 32*) to support this.

Overclocking Performance Menu (Advanced Menu) - For Some Processors Only

This menu will be **available for processors that support CPU overclocking**. Click on **Overclocking Performance Menu** and then click on the **Overclocking Feature** item to enable it (it is **Disabled by default**) and to configure the **Memory** settings.

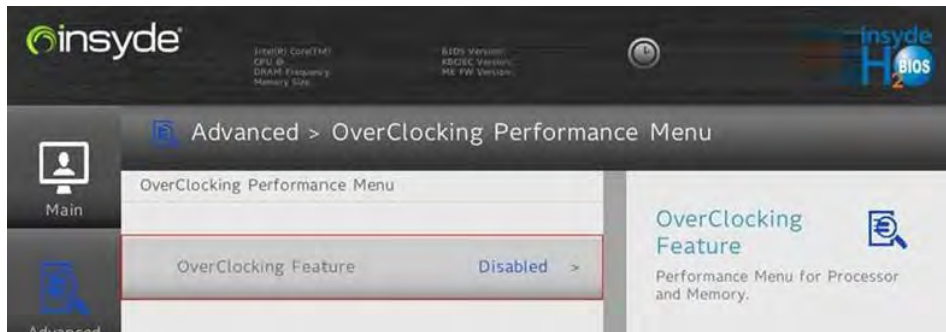

Figure 5 - 10
Overclocking
Feature



Intel® Optane™

Intel® Optane™ is a combination of a compatible memory device and Intel Rapid Technology software. This combination is designed to speed up your system performance.

Contact your distributor or supplier to see if your system supports this technology.

SATA Mode Selection

If you have installed the **Windows** OS with **AHCI**, or **Intel RST (Optane/RAID)** mode enabled, **DO NOT** disable the set mode (if you wish to disable the set mode you will need to reinstall the **Windows** OS).

SATA Mode (Advanced Menu)

The SATA (Serial ATA) control is configured to operate in **AHCI** (Advanced Host Controller Interface) mode or in **Intel RST Premium With Intel Optane System Acceleration** (for either **RAID** or **Intel® Optane™**) mode. *Note that your system can be set up as a RAID OR to support Intel® Optane™, it cannot be set to support both systems.*

The **SATA Mode** should be set **BEFORE installing an operating system**, and after you have backed up all necessary files and data (see sidebar). See **“SATA Mode Setup (Optane™, RAID or AHCI)” on page 6 - 2** for details. Make sure you install the **Intel Rapid Storage Technology application** if you have set the SATA Mode to **Intel RST Premium With Intel Optane System Acceleration (for Optane or RAID)**, or to **AHCI** (see **“IRST Driver Installation” on page 6 - 33**).

If you wish to change your SATA mode to/from AHCI/Intel RST (Optane)/RAID mode note that doing so may prevent your operating system from booting, and may require a reinstall of the OS. If you do wish to change the SATA mode then backup any necessary data on your hard disk(s) as you will need wipe the disks clean in order to prevent system problems.

Power On Boot Beep (Advanced Menu)

Use this menu item to enable/disable the beep as the computer starts up.

Battery Low Alarm Beep (Advanced Menu)

Use this menu item to enable/disable the battery low alarm beep.

Intel(R) Thunderbolt Configuration (Advanced Menu)

You can enable/disable the Intel(R) Thunderbolt port support from this menu (**Discrete Thunderbolt(TM) Support**).

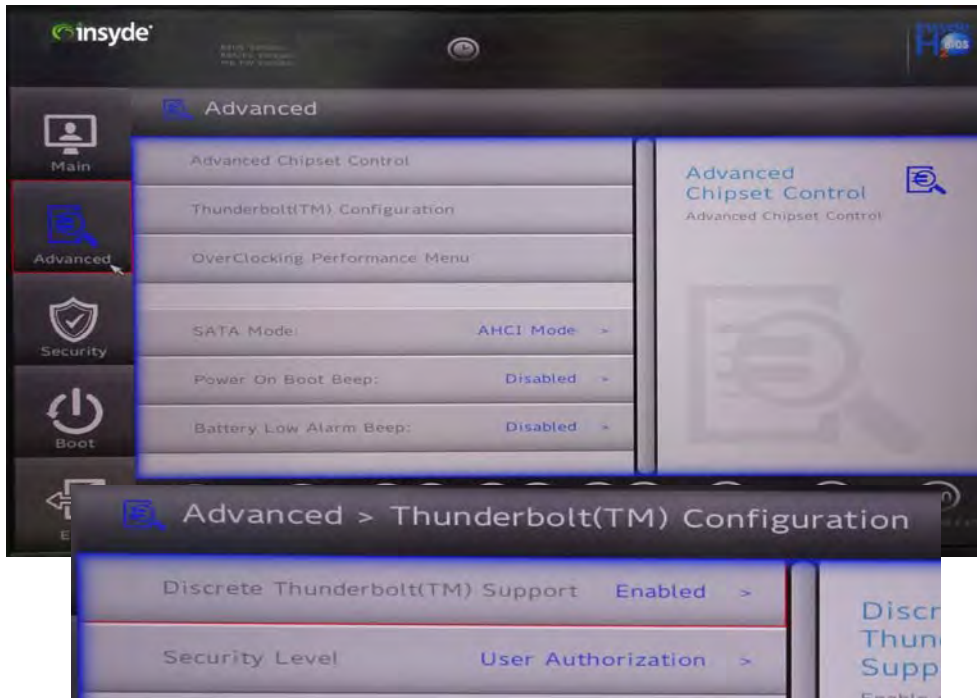

Figure 5 - 11
Intel(R) Thunderbolt
Configuration
(Advanced Menu)

Security Level (Advanced Menu > Thunderbolt(TM) Configuration)

You can set the security level to **No Security**, **User Authorization**, **Secure Connect** or **Display Port only**.

- **No Security mode will allow any devices to be connected.** In this mode the connection manager auto connects to any new devices which are plugged in.
- With **User Authorization** you can set the port to allow only devices with a **Unique ID** to connect. **If the unique ID is not located then you will be asked to confirm the connection.** The connection manager will request approval from the host and auto approval may be given based on the unique ID of the connecting device.
- With **Secure Connect** you can set a **one time saved key** only then **the host will write a unique ID to a device to ensure only approved devices can connect.** The connection manager will request approval from the host, and auto approval is only given if the host challenge to the device is acceptable.
- Setting the port to **Display Port only will only allow display devices to connect to the port, and no data connections will be allowed.** In this mode only displays are connected (re-driver or DP tunnel, no PCIe tunneling) and no tunneling is done for PCIe devices.

Figure 5 - 12
Intel(R) Thunderbolt
Security level
(Thunderbolt
Configuration)



Setup Utility - Security Menu



Set Supervisor Password (Security Menu)

You can set a password for access to the **BIOS**. This will not affect access to the computer OS (only the **BIOS**). An on-screen keyboard is available to assist with keyboard input.



Security Menu

The changes you make here affect the access to the **BIOS** utility itself, and also access to your machine as it boots up after you turn it on. These settings do not affect your machine or network passwords which will be set in your software OS.

5

Figure 5 - 13
Security Menu



Password Warning

If you set a boot password (Password on boot is “Enabled“), **NEVER** forget your password.

The consequences of this could be serious. If you cannot remember your boot password you must contact your vendor and you may lose all of the information on your hard disk.

Note: To clear existing supervisor passwords press **Enter** and type the existing password, then press **Enter** for the new password (without typing any password entry) and **Enter** again to confirm the password clearance. To clear a user password just click on **Clear User Password**.

Set User Password (Security Menu)

You can set a password for user mode access to the **BIOS**. This will not affect access to the computer OS, (only the *Setup* utility) unless you choose to set a **Password on Boot** (see below). Some menu items in the **BIOS** cannot be modified in user mode.

Note: *You can only set the user password after you have set the supervisor password.*

Power on Password: (Security Menu)

Specify whether or not a password should be entered to boot the computer (**you may only set a Power on Password if a supervisor password is enabled**). If “*Enabled*” is selected, only users who enter a correct password can boot the system (see the **warning in the sidebar**). The default setting is “*Disabled*”.

TPM Configuration (Security Menu)

This sub-menu will allow you to enable/disable Trusted Platform Module (TPM) support, and to configure the TPM State. Select **TPM Configuration** and press Enter to access the sub-menu. Press Enter to access the **Security Device Support** menu and select **Enable** to support TPM. To reset the TPM select **Clear TPM** to clear existing TPM information (see *“Trusted Platform Module” on page 6 - 68*).



Figure 5 - 14
Security Menu
TPM Configuration

Setup Utility - Boot Menu

Figure 5 - 15
Boot Menu & EFI

5



BIOS Screens

Note that the BIOS screens pictured on these pages are intended for guidance in setting up your system's BIOS.

BIOS versions are subject to constant change and revision, therefore your computer's actual screens may appear slightly different from those pictured on these pages.

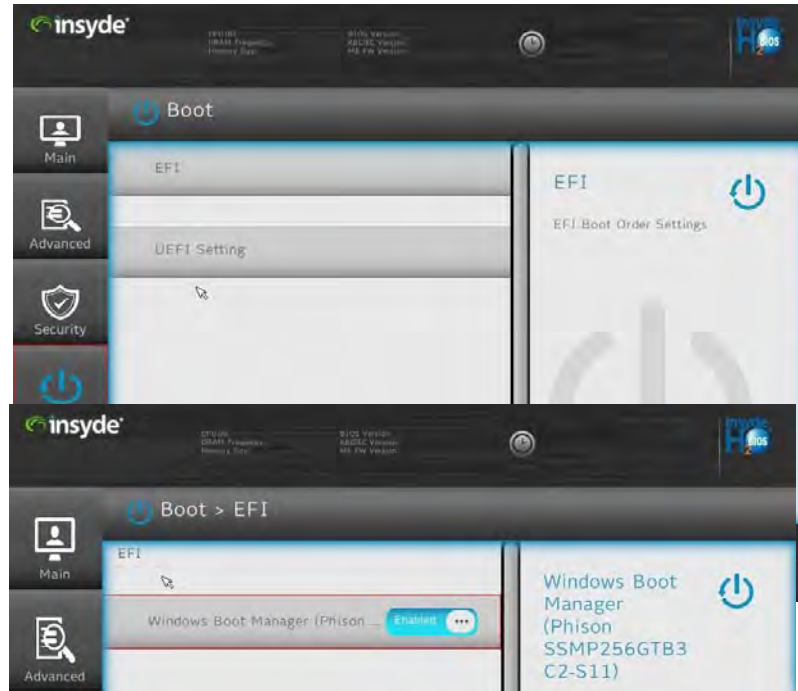

EFI (Boot Menu)

Press Enter to Enable/Disable any available device from which to boot under EFI.

UEFI Setting (Boot Menu)

The Unified Extensible Firmware Interface (UEFI) specification provides a clean interface between operating systems and platform firmware at boot time. In contrast to BIOS, UEFI defines a set of standard boot and runtime services. The **Network Stack** item can be enabled/disabled as an option under **UEFI Setting** and **PXE Boot capability** can be enabled/disabled and configured here.

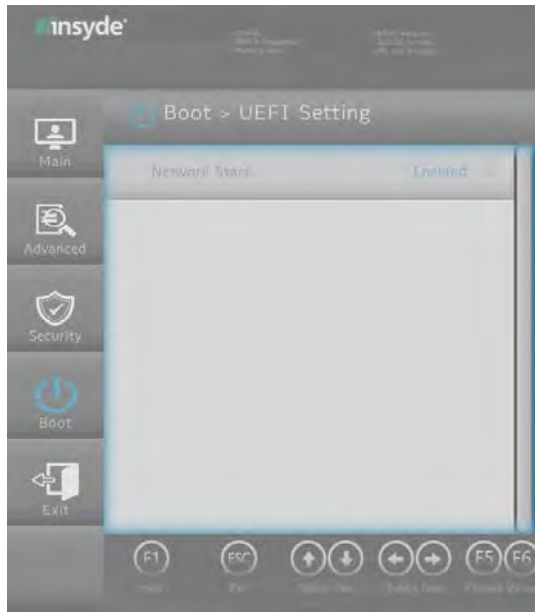

Figure 5 - 16
UEFI Setting

Setup Utility - Exit Menu

Figure 5 - 17
Exit Menu



Click **Exit Saving Changes** (or press **F10**) to save all changes made and exit the BIOS. Choosing **Exit Discarding Changes** will wipe out any changes you have made to the **Setup** and exit the BIOS. You can also choose to **Load Optimal Defaults** (or press **F9**) to return the **BIOS** to its original state, and erase any previous changes you have made in a previous session. Select **Discard Changes** to cancel any changes made in the current session.

Chapter 6: Modules & Options

Overview

This chapter contains information on the following modules, which may come with your computer, depending on the configuration purchased. If you are unsure please contact your service representative.

- SATA Mode Setup (Optane™, RAID or AHCI)
- Wireless LAN Module
- Fingerprint Reader Module
- Bluetooth & WLAN Combo Module
- Thunderbolt Port Driver
- Intel® Software Guard Extensions Driver
- Intel® Rapid Storage Technology
- Sound Blaster Audio
- PC Camera
- Trusted Platform Module



Wireless Device Operation Aboard Aircraft

The use of any portable electronic transmission devices aboard aircraft is usually prohibited. Make sure the **WLAN & Bluetooth module(s) are OFF** (or the system is in **Airplane Mode**) if you are using the computer aboard aircraft (see [Table 1 - 4, on page 1 - 14](#)).



RAID Solid State Drives

All SSDs in a RAID should be identical (the same size and brand) in order to prevent unexpected system behavior.

SATA Mode Selection

The SATA mode selection should be made **before installing your operating system**.

DO NOT change your selected SATA mode unless you intend to reinstall your operating system. Make sure you have backed up all your data before doing so.

See **“SATA Mode (Advanced Menu)” on page 5 - 16**.

SATA Mode Setup (Optane™, RAID or AHCI)

Note that your system can be set up as a RAID OR to support Intel® Optane™, it cannot be set to support both systems.

AHCI Mode

Advanced Host Controller Interface (AHCI) is an interface specification that allows the storage driver to enable advanced serial ATA features such as Native Command Queuing (for maximum hard disk efficiency and performance). Make sure you install the **Intel® Rapid Storage Technology** application to support your HDDs/SSDs in AHCI mode (see **“Intel® Rapid Storage Technology” on page 6 - 33**).

Intel® Optane™

Intel® Optane™ is a combination of a compatible memory device and **Intel Rapid Technology software**. This combination is designed to speed up your system performance by caching boot data, executables, frequently accessed data and system page files to an non volatile, low latency Intel® Optane™ SSD.

Contact your distributor or supplier to see if your system supports this technology.

RAID

To configure your RAID (Redundant Array of Independent Disks) system in Striping (RAID 0) or Mirroring (RAID 1) modes (see **Table 6 - 1, on page 6 - 4**) you will require **at least two identical** (see sidebar) SSDs.

Intel® Rapid Storage Technology Application

Make sure you install the **Intel® Rapid Storage Technology** application if you have set up your SSDs in **AHCI, RAID, OR Optane™** mode (see *“Intel® Rapid Storage Technology” on page 6 - 33*).

After setting the SATA mode to **Intel® Optane™** and installing the **Intel® Rapid Storage Technology** application, **DO NOT** uninstall the **Intel® Rapid Storage Technology** application.

See *“RAID Setup” on page 6 - 5* or *“Intel® Optane™ Setup Procedure” on page 6 - 11* for further details.

Note that your system can be set up as a RAID OR to support Intel® Optane™, it cannot be set to support both systems.



Intel® Optane™

Intel® Optane™ is a combination of a compatible memory device and Intel Rapid Technology software. This combination is designed to speed up your system performance.

Contact your distributor or supplier to see if your system supports this technology.

SATA Mode Selection

If you have installed the **Windows** OS with **AHCI, or Intel RST (Optane/RAID)** mode enabled, **DO NOT** disable the set mode (if you wish to disable the set mode you will need to reinstall the **Windows** OS).

Table 6 - 1
RAID Levels

RAID Level	Description
RAID 0	Identical drives reading and writing data in parallel to increase performance . RAID 0 implements a striped disk array and the data is broken into blocks and each block is written to a separate disk drive.
RAID 1	Identical drives in a mirrored configuration used to protect data . Should a drive that is part of a mirrored array fail, the mirrored drive (which contains identical data) will handle all the data. When a new replacement drive is installed, data to the new drive is rebuilt from the mirrored drive to restore fault tolerance.
Recovery	Two identical drives copying data between a master and a recovery disk. This provides more control over how data is copied between the master and recovery drives, fast volume updates and the ability to view the data in <i>Windows Explorer</i> .



Array Types

A **Mirrored Array (RAID 1)** provides full data protection, as data can simply be copied from a healthy disk to a replacement for any failed disk.

A **Striped Array (RAID 0)** is **NOT** fault-tolerant. The failure of one drive will result in the loss of all data in the array. It is designed to increase disk performance by spreading the I/O load across the channels and drives.



SATA Mode Selection

The SATA mode selection should be made **before installing your operating system**.

DO NOT change your selected SATA mode unless you intend to reinstall your operating system. Make sure you have backed up all your data before doing so.

Solid State Drives

All solid state drives in a RAID should be identical (the same size and brand) in order to prevent unexpected system behavior.

RAID Setup

To configure your RAID (Redundant Array of Independent Disks) system in Striping (RAID 0), Mirroring (RAID 1) or Recovery modes (see *Table 6 - 1, on page 6 - 4*) you will require **two identical** solid state drives.

You need to setup a RAID before installing your *Windows 10* operating system, and you will need to prepare the following in order to do so.

-
- The *Microsoft Windows 10 OS DVD*.
 - A connected external DVD drive.
 - Two Identical solid state drives.
 - The *Device Drivers & Utilities + User's Manual* disc.
-

(see over)

Modules & Options

1. Start up your notebook computer and press <F2> to enter the **BIOS** and go to the **Setup Utility**.
2. Select the **Advanced** menu.
3. Select **SATA Mode** (see page 5 - 16), press <Enter> and select “**Intel RST Premium With Intel Optane Acceleration**” and select <OK>.
4. Press <F10> to “**Save and Exit**” and select <Yes> .
5. As the computer restarts press <F2> to enter the **BIOS** again and go to the **Setup Utility**.
6. Go to **Intel(R) Rapid Storage Technology (Advanced menu)** and select “**Create RAID Volume**”.

6

Figure 6 - 1
Create RAID Volume

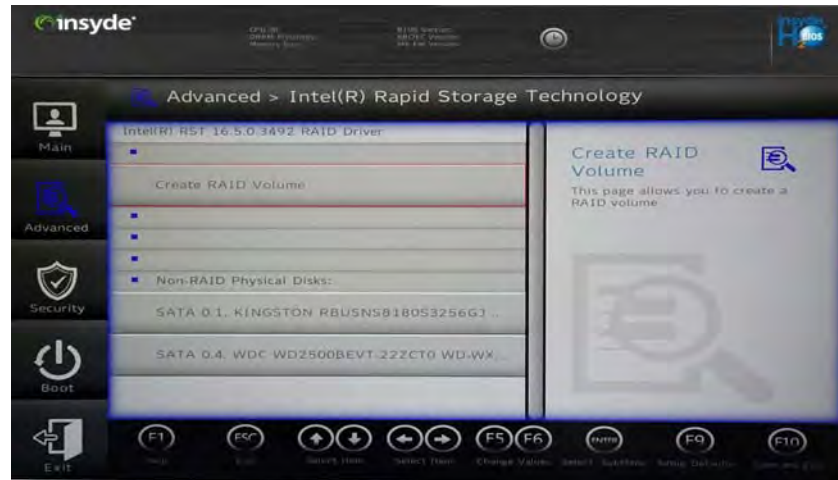

7. You can now setup your RAID volume using the installed SSDs.
8. Select “**Name**” and type a name of your choice for your RAID volume and select <Yes>.
9. Select **RAID Level** and choose the RAID Level required (see [Table 6 - 1, on page 6 - 4](#) for details) and press <Enter>.
 - **RAID0 (Stripe)**
 - **RAID1 (Mirror)**
 - **Recovery**
10. Go to any of the disks listed under “**Select Disks:**” and select a disk name.
11. Click on **X** to select the disk required.

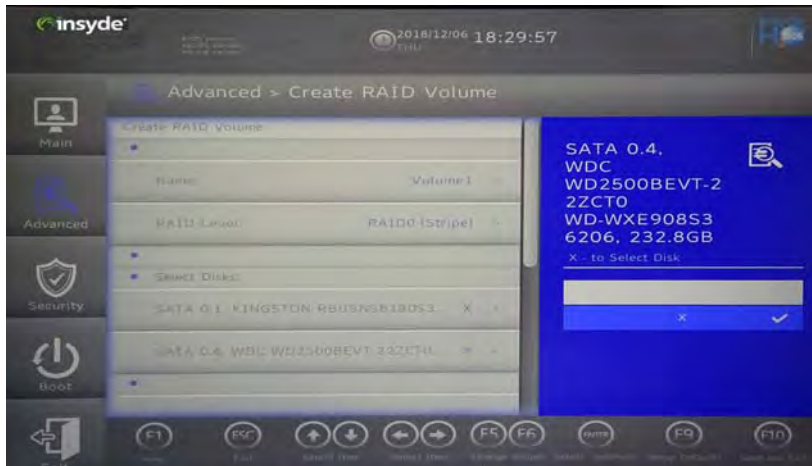

Figure 6 - 2
Select Disks

Modules & Options

12. You should select two identical SSDs to form your RAID volume.
13. If you have selected **RAID0 (Stripe)** then you can adjust the “**Strip Size**” to (you can use the cursor to move up and down the menu selection) your requirements (*it is recommended that you set the “Strip Size” to 128KB*).
14. If you have selected **Recovery** then you will need to set a **Master Disk** and **Recovery Disk**.
15. Select **Create Volume** (make sure you have selected your disks).



Figure 6 - 3
Create Volume

16. The system will list your RAID volume.
17. Press <F10> to “**Save and Exit**” and select <Yes>, however note below.
 - Make sure the **Windows 10** OS DVD is in the attached DVD drive, as the computer starts up it will automatically boot from the **Windows 10** OS DVD (you will be prompted to press a key to boot from the DVD).
18. Press <F2> as the computer starts up to select the drive containing the **Windows 10** OS DVD as the boot device in **Boot Manager**.
19. Press a key at system startup to begin installing **Windows** from your **Microsoft Windows 10** disc.
20. Click **Next > Install Now** to continue installing the operating system as normal (see your **Windows** documentation if you need help on installing the **Windows** OS).
21. Follow the on-screen instructions to install the **Windows 10** operating system.
22. Install the **Windows** drivers from the **Device Drivers & Utilities + User’s Manual** disc as per **Table 4 - 1, on page 4 - 5** (make sure you install the **Intel Rapid Storage Technology driver** - see overleaf).
23. Run the **Intel® Rapid Storage Technology** application to manage your RAID volume as instructed in **“Intel® Rapid Storage Technology for Optane Systems” on page 6 - 45**.

Deleting a RAID

If you wish to delete an existing RAID then follow the procedure below to do so. However **backup up any necessary files and data before deleting a RAID**, as doing so will result in the loss of all data on the RAID volumes.

1. Start-up your notebook computer and press <F2> to enter the **BIOS**.
2. Select **Intel(R) Rapid Storage Technology** (in the **Advanced** menu).
3. Select the RAID (listed under **RAID Volumes:**).
4. Select **Delete**.
5. Select **“Yes”** (note that all the data on the volumes will be lost).

6

Figure 6 - 4
Delete RAID

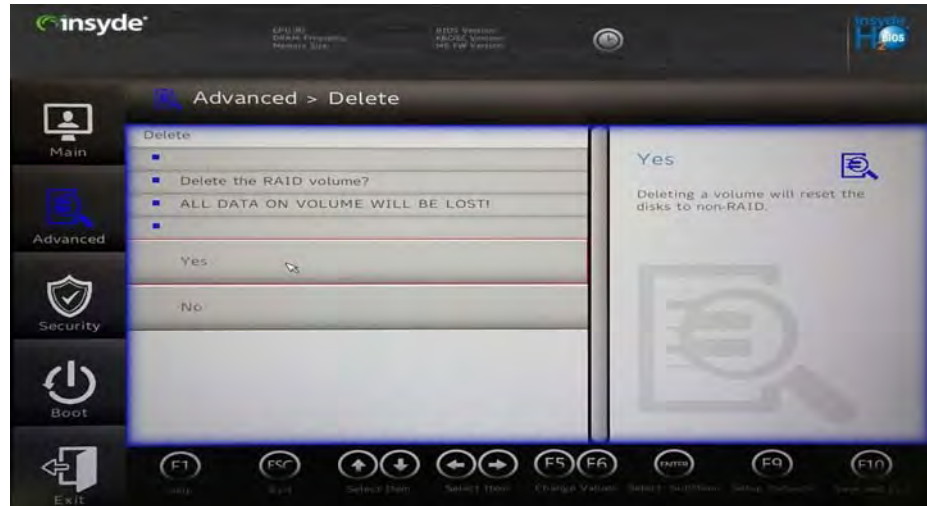

Intel® Optane™ Setup Procedure

After initial setup make sure you install the **Intel Rapid Storage Technology driver** - see *“IRST Driver Installation” on page 6 - 33*).

You need to setup **Intel® Optane™** before installing your *Windows 10* operating system, and you will need to prepare the following in order to do so.

-
- The *Microsoft Windows 10 OS on a DVD or USB flash drive*.
 - An Intel® Optane™ SSD installed in your system.
 - The *Device Drivers & Utilities + User’s Manual* disc.
-
1. Start-up your notebook computer and press <F2> to enter the **BIOS**.
 2. Select **Setup Utility** and go to the **Advanced** menu.
 3. Select **SATA Mode** (see page **5 - 16**), press <Enter> and select **“Intel RST Premium With Intel Optane Acceleration.”**

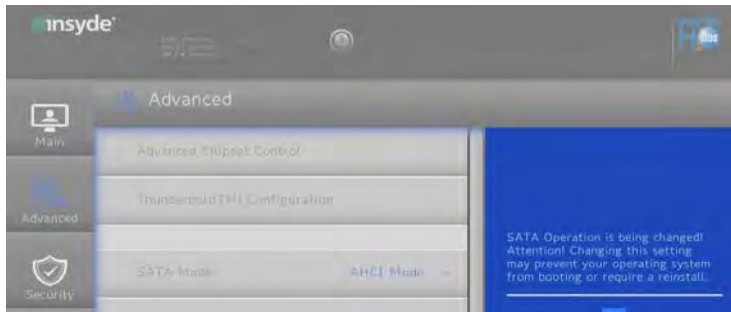



Figure 6 - 5
SATA Mode



Optane SSD Module Removal

If you need to remove an installed Optane SSD module for any reason, **you must disable** (see *“Disabling Intel® Optane™” on page 6 - 49*) Intel Optane before doing so.

Failure to disable Optane before removing an Optane SSD module will result in the system being unable to start up.

4. Select “**Save and Exit**”.
5. As the computer restarts press <F2> to enter the **BIOS** again.
6. Go to the **Setup Utility**, and go to the **Advanced** menu and you will now see the **Intel(R) Rapid Storage Technology** item. You can press <Enter> to check the information.

*(Note this item only appears after you have restarted and accessed the BIOS again after having set **SATA Mode** to **Intel RST Premium With Intel Optane Acceleration**)*

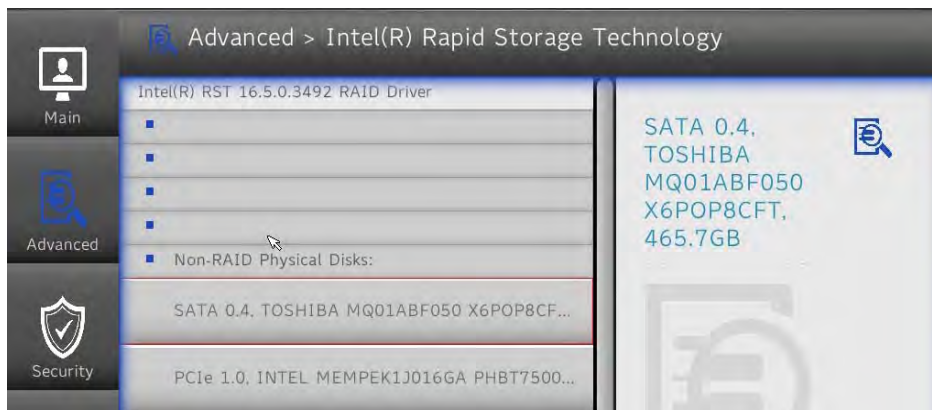

7. Select “**Save and Exit**”, and make sure the **Windows 10** OS DVD is in the DVD drive, or on a USB flash drive, as the computer starts up it will automatically boot from the **Windows 10** DVD or flash drive.
8. Press <F2> as the computer starts up and select **Boot Manager**.
9. Click to select the drive containing the **Windows 10** OS.

6
Figure 6 - 6
Intel(R) Rapid Storage Technology

10. Press a key at system startup to begin installing **Windows** from your **Microsoft Windows 10** disc.
11. Click **Next > Install Now** to continue installing the operating system as normal (see your **Windows** documentation if you need help on installing the **Windows OS**).
12. Follow the on-screen instructions to install the **Windows 10** operating system.
13. Install the **Windows** drivers from the **Device Drivers & Utilities + User's Manual** disc as per **Table 4 - 1, on page 4 - 4** (make sure you install the **Intel Rapid Storage Technology driver** - see overleaf).
14. Run the **Intel® Rapid Storage Technology/Intel® Optane™ Memory and Storage Management** application to manage your **Intel® Optane™** system as instructed in **"Intel® Rapid Storage Technology" on page 6 - 33**.
15. After installing the **Intel® Rapid Storage Technology/Intel® Optane™ Memory and Storage Management** application you can access **Device Manager** (right-click the **Start** menu and select **Device Manager**).
16. Click **Disk drives** to check the Optane drive.

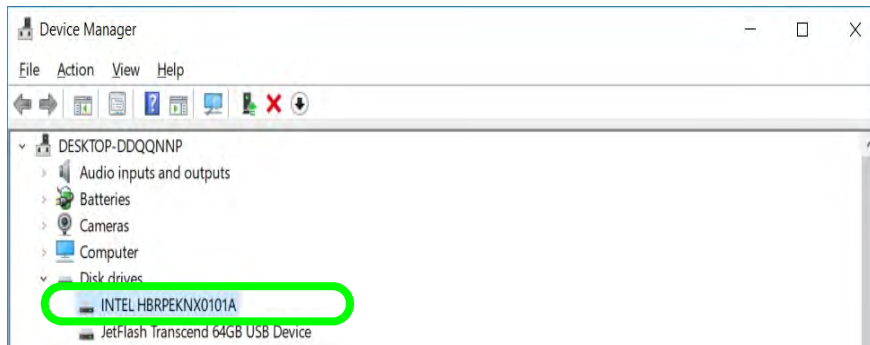

Figure 6 - 7
Device Manager



Wireless Device Operation Aboard Aircraft

The use of any portable electronic transmission devices aboard aircraft is usually prohibited. Make sure the **WLAN & Bluetooth module(s)** are **OFF** if you are using the computer aboard aircraft by putting the system in to **Airplane Mode** (see [Table 1 - 4, on page 1 - 14](#)).

Wireless LAN Module

If your purchase option includes a **Combination Wireless LAN & Bluetooth module** (either **Intel®** or **Killer**) then install the driver for the appropriate module as instructed below.

- See *“Intel® WLAN Driver Installation” on page 6 - 15.*
- See *“Killer WLAN Combo Driver Installation” on page 6 - 16.*

Make sure that the module is on (i.e. the system is not in **Airplane Mode**) before installing the driver.

Make sure you install the drivers in the order indicated in [Table 4 - 1, on page 4 - 5](#).

Note that you need to install both the WLAN & Bluetooth drivers for the WLAN & Bluetooth Combo modules.

Intel® WLAN Driver Installation

1. **Make sure the system is not in Airplane Mode**, and then insert the *Device Drivers & Utilities + User's Manual* disc into an attached DVD drive.
2. Click **Option Drivers** (button).
3. Click **1.Install WLAN Driver > Yes**.
4. Click **Next**.
5. Click in the check box to agree to the **End User License Agreement** and click **Install**.
6. Click **Finish**.
7. The operating system is the default setting for Wireless LAN control in *Windows* (see page **6 - 17**).



Uninstalling The WLAN Driver

Note that if you need to uninstall the WLAN driver, and it does not appear in the *Programs and Features control panel*, you will need to do so from the Device Manager.

To uninstall the driver from Device Manager, right-click the Start Menu icon  in the taskbar and select **Device Manager**. Right-click the WLAN device and then select **"Uninstall device"** (make sure to tick the box **"Delete the driver software for this device"**) to start the process.

After the driver is uninstalled click the icon  at the top of Device Manager to **"Scan for hardware changes"**.



Uninstalling The WLAN Driver

Note that if you need to uninstall the WLAN driver, and it does not appear in the *Programs and Features control panel*, you will need to do so from the Device Manager.

To uninstall the driver from Device Manager, right-click the Start Menu icon  in the taskbar and select **Device Manager**. Right-click the WLAN device and then select “**Uninstall device**” (*make sure to tick the box “Delete the driver software for this device”*) to start the process.

After the driver is uninstalled click the icon  at the top of Device Manager to “Scan for hardware changes”.

Killer WLAN Combo Driver Installation

1. **Make sure the system is not in Airplane Mode**, and then insert the *Device Drivers & Utilities + User’s Manual* disc into the DVD drive.
2. Click **Option Drivers** (button).
3. Click **1.Install WLAN Driver > Yes**.
4. Select the language preferred and click **Next**.
5. Click **Next > Next**.
6. Click in the check box to accept to the **License Agreement** and click **Next**.
7. Click **Finish**.
8. Click **Yes** to restart the computer.
9. The operating system is the default setting for Wireless LAN control in *Windows* (see page **6 - 17**).
10. **You can then download the Killer Control Center App from the Microsoft Store** but you will need to have a working internet connection.
11. After the driver is installed an automatic browser window will pop-up and you can click the “**Get**” button to start the installation.
12. Alternatively click the **Start** menu in Windows to access the **Microsoft Store App** tile under **Explore**.
13. You can then search by typing “**Killer Control Center**” in the search window (click the magnifying glass icon in the top right corner of the screen) and click to install the App.
14. When just installed the **Killer Control Center** will appear in the **Windows Start** menu.

WLAN Configuration in Windows 10

You can configure a wireless connection using one of the following options, however make sure the Wireless LAN module is turned on (and not in Airplane Mode) before configuration begins.

1. Click the Wireless icon  in the notification area of the taskbar.
2. Make sure that **Airplane mode** is **off** (the Airplane mode icon should be gray).
3. A list of available access points will appear.
4. Double-click an access point to connect to it (or click it and click **Connect**).

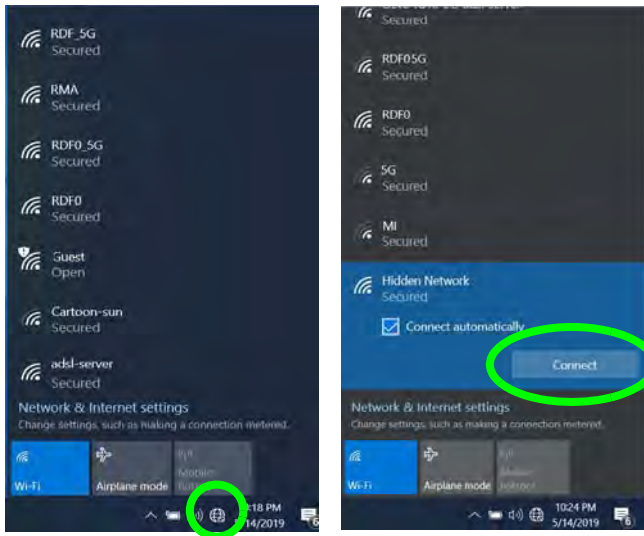

Figure 6 - 8
WiFi & Network
Connections

Modules & Options

5. Enter a network security key (password) if required, and click **Next**.
6. You can choose to share or connect to devices or not.
7. When you are connected to the network access point it will display **Connected** status **Connected**.
8. Select any connected network and click **Disconnect** **Disconnect** to disconnect from a connected access point.



Wireless Device Operation Aboard Aircraft

The use of any portable electronic transmission devices aboard aircraft is usually prohibited.

Make sure the module is either **OFF** or in **Airplane mode** if you are using the computer aboard aircraft.

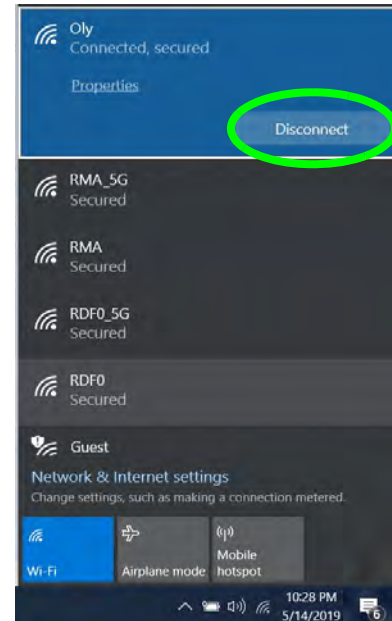

6

Figure 6 - 9
**Network Connected
(Click Disconnect)**

9. You can click the **Airplane Mode** button to turn the mode On or Off.
10. You need to either use **Airplane Mode**, or to **turn the WLAN module off** aboard aircraft.
11. If you click on **Network Settings** to bring up **Network & Internet** for a more comprehensive list of network and internet settings including **Wi-Fi** (can be turned on/off), **Airplane mode** (Airplane mode and Wireless devices can be turned on/off) **VPN**, **Dial-up**, **Ethernet** and **Proxy**.

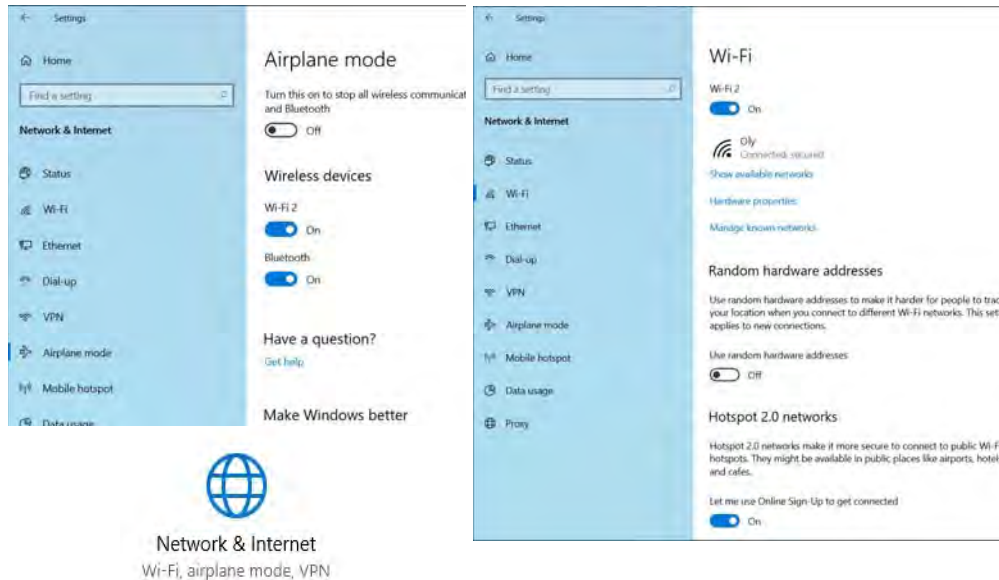

Figure 6 - 10
Network & Internet Settings



Fingerprint Reader and Power Saving States

If your computer is in a power saving state (e.g. Hibernate or Sleep) you should keep your finger clear of the fingerprint sensor.

Allow the system to fully resume before scanning your finger.

Fingerprint Reader Module

The fingerprint reader module provides a high level of security for your computer. Make sure you have administrator's rights to your computer, and have a **Windows** password enabled for full security protection.

Install the driver from the *Device Drivers & Utilities + User's Manual disc* by following the appropriate instructions overleaf.

Fingerprint Reader Driver Installation

1. **Make sure the system is not in Airplane Mode**, and then insert the *Device Drivers & Utilities + User's Manual* disc into the DVD drive.
2. Click **Option Drivers**.
3. Click **2.Install Fingerprint Driver > Yes**.
4. Click **OK** to complete the installation.
5. The fingerprint reader module uses the **Sign-in options** configuration of the **Windows Account** (see overleaf).



Fingerprints

When fingers are wet or sweaty the software application may have difficulty reading a scanned finger. Make sure your fingers are clean and dry when attempting to scan them on the sensor for detection.



PIN Code

You will be asked to add a PIN code when setting up the Fingerprint Reader. This is in addition to your windows password.

Note this code as it may be required to help you sign-in if there are any issues with using the fingerprint reader to sign-in (see *"Fingerprint Sign-In Issues"* on page 6 - 23).

Fingerprint Module Configuration

1. Click the **Settings** item in the Start Menu and then click **Accounts** and click **Sign-in options**.
2. You will need to add a **Windows** password (click **Add** under **Password**).
3. After you have added the password you will need to also add a **PIN**.
4. Click **Set up** under **Windows Hello Fingerprint**.
5. The wizard will then guide you through the set up process to scan your fingerprints.

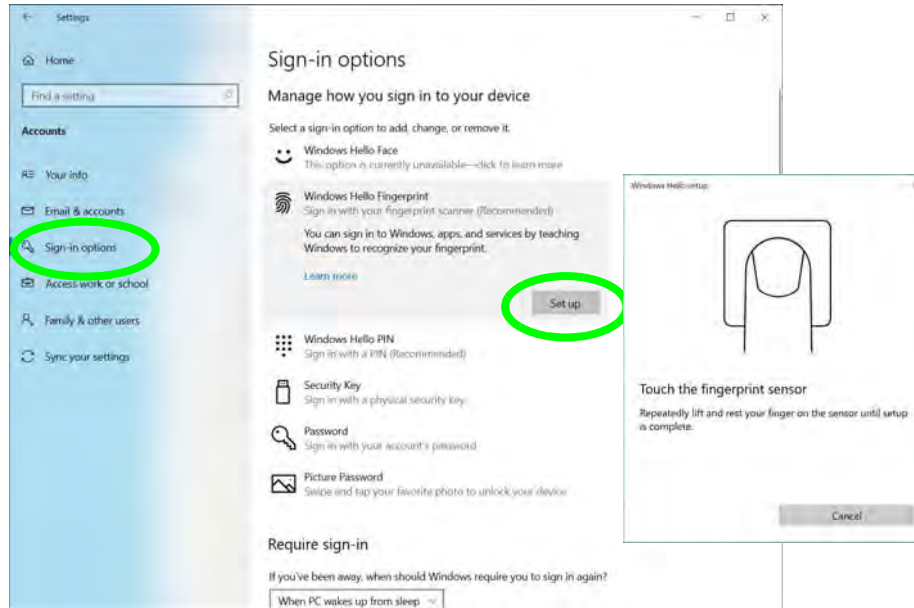
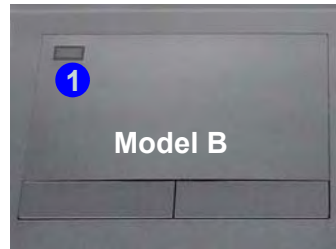
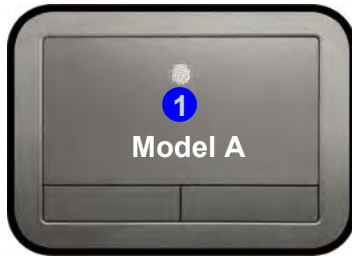

Figure 6 - 11
Accounts - Sign-in options (Add Fingerprint)

- The fingerprint sensor in the Touchpad will flash, so repeatedly rest your finger on the sensor, and then lift it off until the setup is complete as instructed.



1.Fingerprint Reader Sensor

- You will be instructed to **scan the same finger** on the reader a number of times (**this may be in excess of 20 times**).
- Try to present different parts of your finger in different positions similar to the various positions you may use when using it, and note the following:
 - Hold the finger on the sensor for at least half a second.**
 - Make sure that you make firm direct contact with the sensor, and cover the entire area of the sensor with the finger (you are looking for a reading of at least 75% of the finger area). Use a a pressing motion as opposed to a touching or tapping motion.**
 - When authenticating use the same sort of angle you used for enrollment.**
- Click **Close** when complete.
- You can choose to **Add another** finger (this is recommended) or **Remove** the current fingerprint reading.
- You can now touch to scan your fingerprint to log-on to the computer.

Figure 6 - 12
Fingerprint Sensor



Fingerprint Sign-In Issues

If at the Windows Hello screen, **the Fingerprint reader fails to recognize the fingerprint 3 times it will then block access to the computer.**

In this case you will need to use your PIN (the PIN you used when initially setting up the fingerprint reader) **to access the computer.** Alternatively you can sign-in using your windows password.

After using the PIN code (or windows Password) to access the computer you can go to the **Settings > Accounts > Sign-in options** if you wish to change any settings.



Wireless Device Operation Aboard Aircraft

The use of any portable electronic transmission devices aboard aircraft is usually prohibited. Make sure the **WLAN & Bluetooth module(s)** are **OFF** if you are using the computer aboard aircraft by putting the system in to **Airplane Mode** (see [Table 1 - 4](#), [on page 1 - 14](#)).

6

Bluetooth & WLAN Combo Module

If you have included a **Wireless LAN & Bluetooth Combo module** is on (i.e. the system is not in **Airplane Mode**) before installing the driver.

Make sure you install the drivers in the order indicated in [Table 4 - 1, on page 4 - 5](#). You will need to install both the WLAN and Bluetooth drivers for all the combo modules. **The Bluetooth drivers for both modules are installed as instructed overleaf.**



Bluetooth Data Transfer

Note that the transfer of data between the computer and a Bluetooth enabled device is supported in one direction only (simultaneous data transfer is not supported). Therefore if you are copying a file from your computer to a Bluetooth enabled device, you will not be able to copy a file from the Bluetooth enabled device to your computer until the file transfer process from the computer has been completed.

Note that you need to install both the WLAN & Bluetooth drivers for the WLAN & Bluetooth Combo modules.

Intel & Killer Bluetooth Combo Driver Installation

The Bluetooth drivers for both modules are installed as below.

1. **Make sure the system is not in Airplane Mode**, and then insert the *Device Drivers & Utilities + User's Manual* disc into an attached DVD drive.
2. Click **Option Drivers** (button).
3. Click **3.Install Combo BT Driver > Yes**.
4. Click **Next**.
5. Click in the check box to accept the license and click **Next**.
6. Select the setup type (**Typical** is recommended) and click **Install**.
7. Click **Finish**.
8. See *“Bluetooth Configuration in Windows” on page 6 - 26* for configuration instructions.

Bluetooth Configuration in Windows

1. Go to the **Settings** control panel and click **Devices** (or click the Bluetooth icon  in the taskbar and click **Add a Bluetooth Device**).
2. Click **Bluetooth & other devices** and make sure Bluetooth is **On**.
3. Click **Add Bluetooth or other device** > **Bluetooth (Add a device)** and a list of discovered devices will appear.

Figure 6 - 13
Settings > Bluetooth & Other Devices (Add a Bluetooth Device)

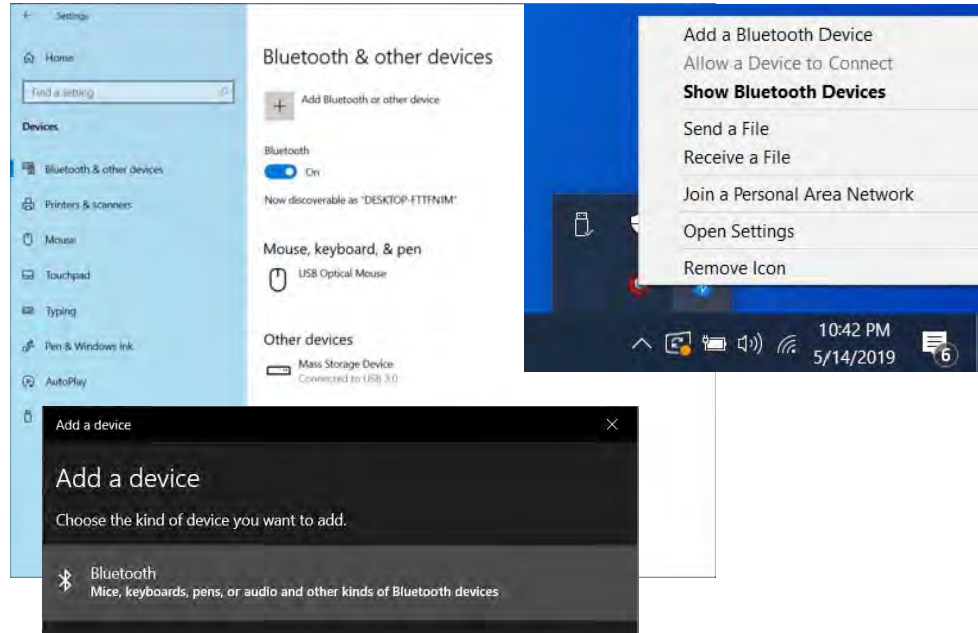

Figure 6 - 14
Add a Device

- Double-click the device you want to pair with the computer and click **Connect**, if the PIN matches that on the device to which you wish to connect (you may need to click **paired** on the device).

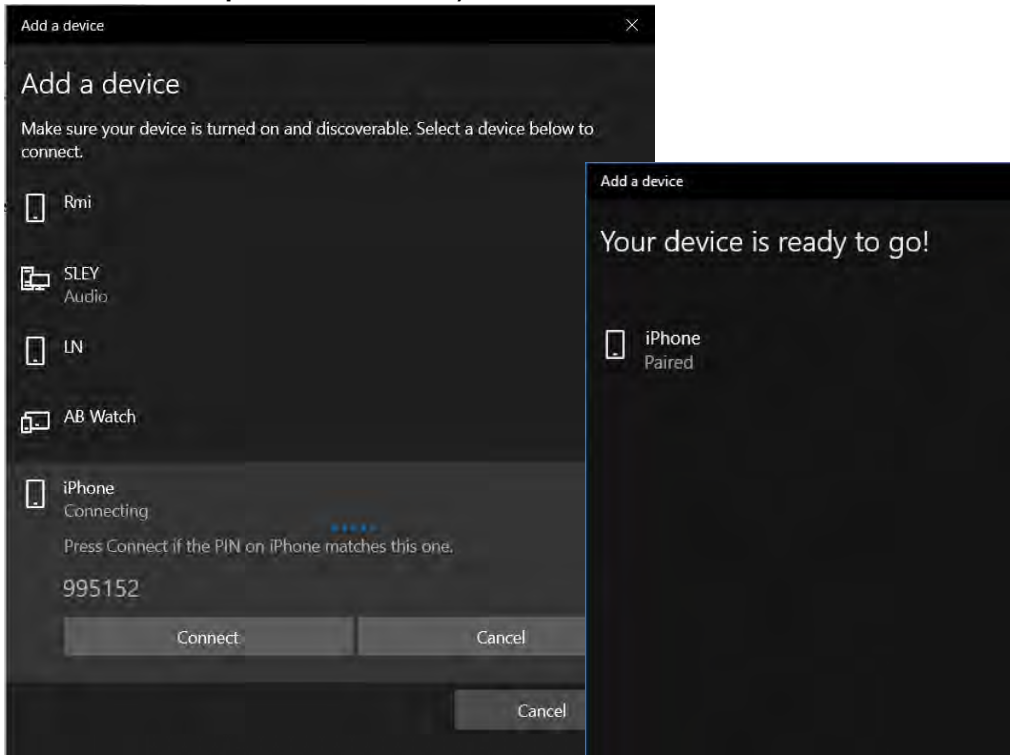
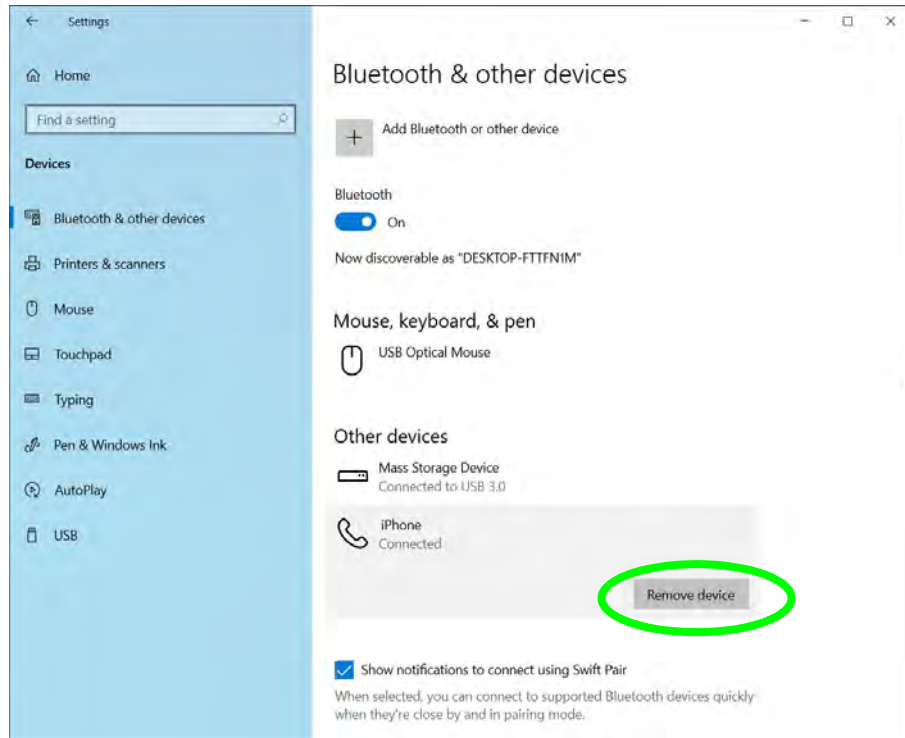



Figure 6 - 15
Bluetooth Connect

5. Select a device and click **Remove Device** Remove device to disconnect from any device (click **Yes** to confirm).

Figure 6 - 16
Bluetooth Remove Device



To Make your Computer Discoverable to Bluetooth Devices

1. Go to the **Settings** control panel and click **Devices** (or click the Bluetooth icon  in the taskbar and click **Open Settings**).
2. Click **Bluetooth & other devices** and click **More Bluetooth options**.
3. In **Bluetooth Settings** make sure that **Allow Bluetooth devices to find this PC** check box (**Discovery**) has a check inside it.
4. Make sure that the **Alert me when a new Bluetooth device wants to connect** check box (**Notifications**) has a check inside it, if you want to be notified when a Bluetooth device wants to connect.

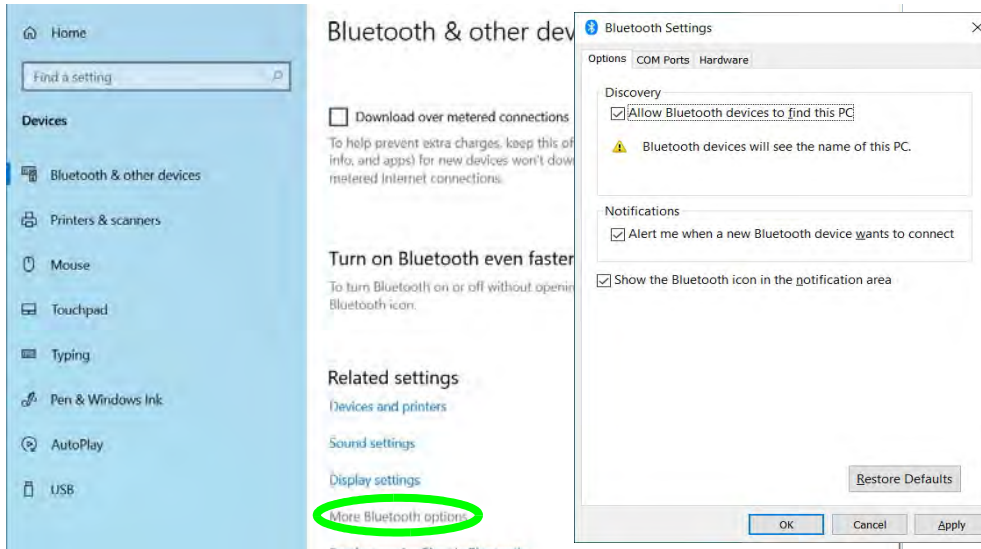

Figure 6 - 17
Bluetooth Settings

Thunderbolt Port Driver

If you have included the **Thunderbolt 3 port (factory option)** in your purchase configuration then you need to install the driver.

Before installing the Thunderbolt driver it is necessary to initialize the port first. To do so simply insert any USB Type C device (e.g. a USB flash drive) into the combo port (see [Figure 1 - 9 on page 1 - 19](#)). You may then install the driver as below.

6

1. Insert the *Device Drivers & Utilities + User's Manual* disc into an attached DVD drive.
2. Click **Option Drivers** (button).
3. Click **4.Install Thunderbolt Driver > Yes**.
4. Click **OK > OK** (make sure you click all the OK messages which pop-up) to complete the installation.
5. See also *“[Intel\(R\) Thunderbolt Configuration \(Advanced Menu\)](#)” on [page 5 - 17](#)* and overleaf for Thunderbolt port configuration.



Thunderbolt Port Devices

If your purchase option includes a Thunderbolt port note the following:

When plugging a device into a Thunderbolt port allow 30 seconds for the system to scan and recognize the connected device.

Ejecting Thunderbolt Devices

In order to prevent system problems make sure you **do not simply pull the cable out from the Thunderbolt port**. The hardware must be ejected safely:

1. Go to the notification area of the taskbar in the Desktop App and click on the **Safely Remove Hardware and Eject Media** icon.
2. Click on Eject "*Thunderbolt Device Name*".
3. When you see the "**Safe to Remove Hardware**" message **you can remove the cable after about 20 seconds**, to make sure that it is safe to eject the device.

Thunderbolt Port Security Level

The security level (including setting the port for display devices) for the Thunderbolt port can be set up in the BIOS (see "**Security Level (Advanced Menu > Thunderbolt(TM) Configuration)**" on page 5 - 18).

Intel® Software Guard Extensions Driver

Install the **Intel® Software Guard Extensions Driver** which provides a set of instructions allowing user-level code a degree of security, and privacy, from the operating system. **Make sure that SW Guard Extensions is Enabled in the BIOS before installing the driver** (see “*Software Guard Extensions (SGX) - (Advanced Menu > Advanced Chipset Control)*” on page 5 - 15).

Intel SGX Driver Installation

1. Insert the *Device Drivers & Utilities + User’s Manual* disc into an attached DVD drive.
2. Click **Option Drivers** (button).
3. Click **5.Install SGX Driver > Yes**.
4. Click **OK > OK** (make sure you click both OK messages) to complete the installation.

Intel® Rapid Storage Technology

The **Intel® Rapid Storage Technology** driver supports your AHCI mode SATA drive, or your **Intel® Optane™** system. Install the **Intel Rapid Storage Technology application/Intel® Optane™ Memory and Storage Management** (after installing all necessary drivers in the correct order) to support your **Optane** system or SATA drive if set up in **AHCI or RAID mode** in the BIOS (see “*SATA Mode (Advanced Menu)*” on page 5 - 16).

IRST Driver Installation

1. Insert the *Device Drivers & Utilities + User's Manual* disc into an attached DVD drive.
2. Click **Option Drivers** (button).
3. Click **6.Install IRST Driver > Yes**.
4. Click **Next**.
5. Click in the check box to accept the license and click **Next**.
6. Click **Next > Next > Next**.
7. Click **Finish** to restart the computer.
8. Run the **Intel® Rapid Storage Technology** app from the **Apps** screen.

After setting the SATA mode to **Intel® Optane™** and installing the **Intel® Rapid Storage Technology/Intel® Optane™ Memory and Storage Management** application, **DO NOT** uninstall the **Intel® Rapid Storage Technology/Intel® Optane™ Memory and Storage Management** application.

Intel® Rapid Storage Technology Apps

Note that, at the time of going to press, there are two management apps related to Optane technology management. The applications can be run from the Start menu and you can **choose to run either one listed below (however do not run both apps at the same time or you will receive an error message):**

- Intel(R) Rapid Storage Technology Management
- OR
- Intel® Optane™ Memory and Storage Management

Intel® Optane™ Memory & Storage Management

Run **Intel® Optane™ Memory & Storage Management** from the Start menu in Windows (*note do not run Intel® Optane™ Memory & Storage Management and Intel® Rapid Storage Technology application at the same time*).

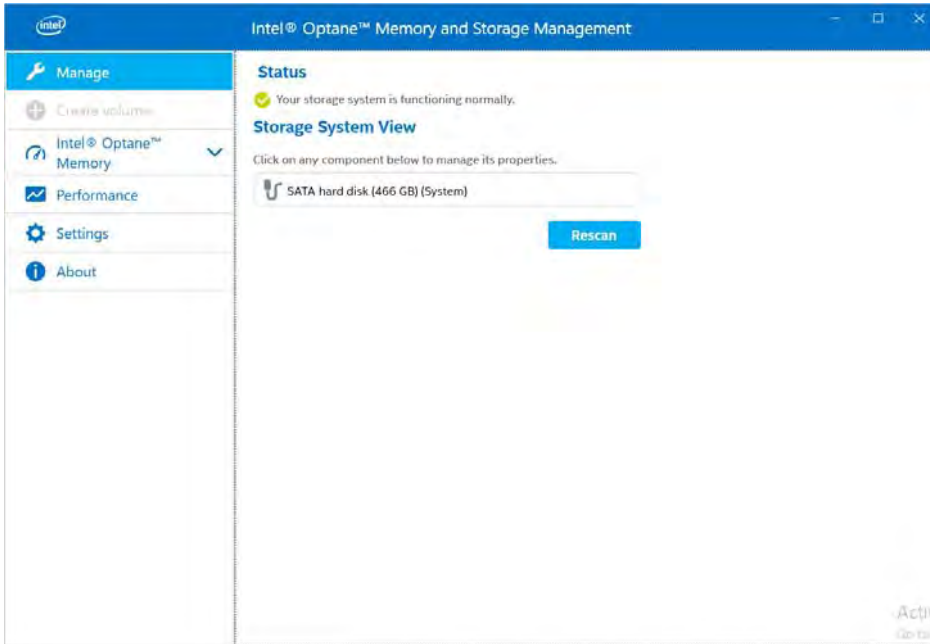
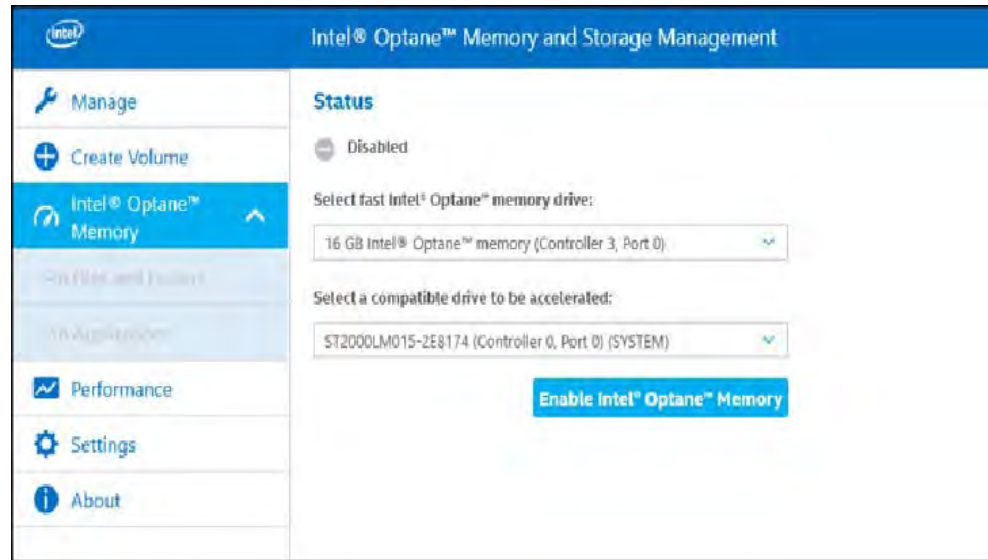

Figure 6 - 18
**Intel® Optane™
 Memory & Storage
 Management**

There are five areas on the left panel of the application and you can click on **Intel® Optane™ Memory** to manage system acceleration with the Optane memory system. Select the Optane memory module, and then click **Enable Intel® Optane™ Memory** to start the process.

Figure 6 - 19
**Intel® Optane™
Memory & Storage
Management
(Intel® Optane™
Memory)**



Enabling Intel® Optane™ (Intel® Optane™ Memory & Storage Management)

1. Run the **Intel® Optane™ Memory & Storage Management** application.
2. Click **Enable Intel® Optane™ Memory**.

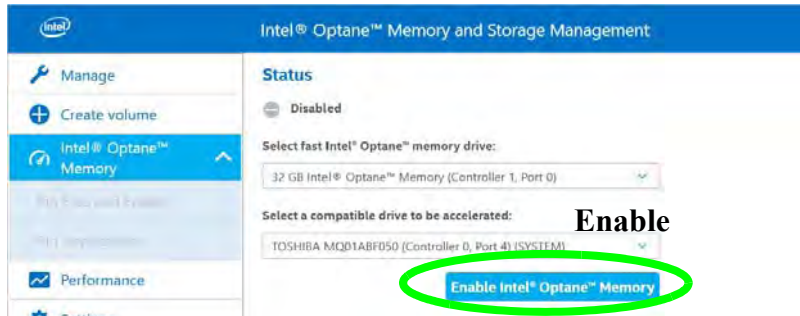

Figure 6 - 20
Enable Intel®
Optane™ Memory

3. A warning will pop up to notify you that the Optane Memory Module will be erased, and if this is OK than click **Enable**.

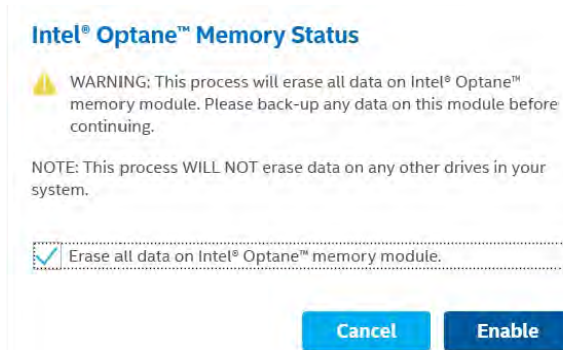

Figure 6 - 21
Warning

Modules & Options

- The system will prepare and enable the Optane drive, and when finished you can then click **Restart**.

Figure 6 - 22
Restart

Restart Is Required

To work with Intel® Optane™ memory, restart is required.

Restart

- The system will then optimize the Optane Memory upon restart.
- Run the **Intel® Optane™ Memory & Storage Management** application.
- The system status will then be displayed.

Figure 6 - 23
Status

The screenshot shows the Intel Optane Memory and Storage Management application. The interface has a blue header with the Intel logo and the title "Intel® Optane™ Memory and Storage Management". On the left is a navigation menu with options: Manage (selected), Create volume, Intel® Optane™ Memory, Pin Files and Folders, Pin Applications, Performance, Settings, and About. The main content area is titled "Status" and shows a green checkmark indicating "Your storage system is functioning normally." Below this is the "Storage System View" section, which includes a "Storage System View" title and a note: "Click on any component below to manage its properties." Underneath, there is a "Storage System View" box containing two storage components: "PCIe (27 GB)" and "SATA (466 GB)". To the right of these components is a box titled "Intel® Optane™ Memory Volume" with the text "Type: Intel® Optane™ Memory" and "466 GB". At the bottom right of the main content area is a blue "Rescan" button.

8. You can **Pin Files and Folders** or **Pin Applications** so that they will always benefit from the speed of Optane Memory from the appropriate sidebar menus.

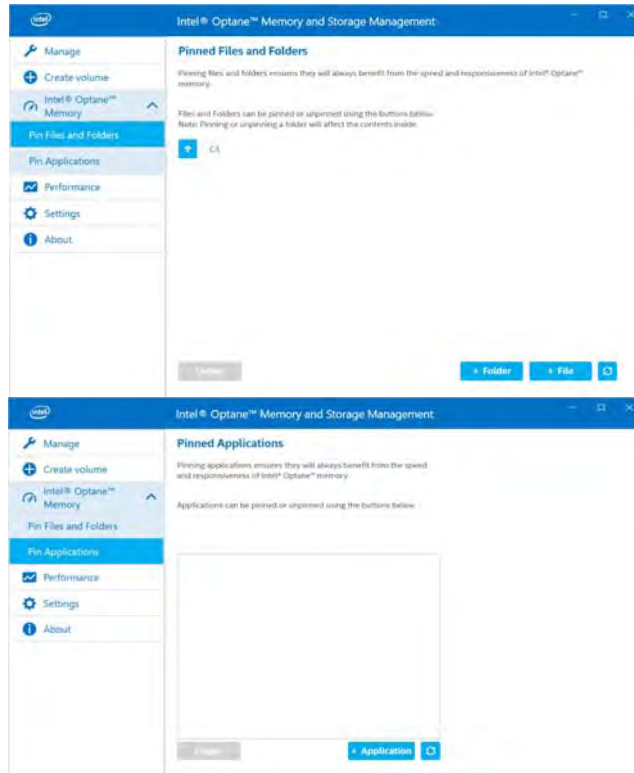

Figure 6 - 24
Pin Files, Folders & Applications

Intel® Rapid Storage Technology for RAID Systems

Intel® Rapid Storage Technology application displays status information on your RAID configuration. Run the **Intel® Rapid Storage Technology** application from the item in the **Start** menu.

When the **Intel® Rapid Storage Technology** application is launched the system will open the **Status** window. Here you can view the general health of the storage system. Various volume creation and management options are available depending on the system's status.

6

Figure 6 - 25
**Intel® Rapid
Storage Technology
Status**

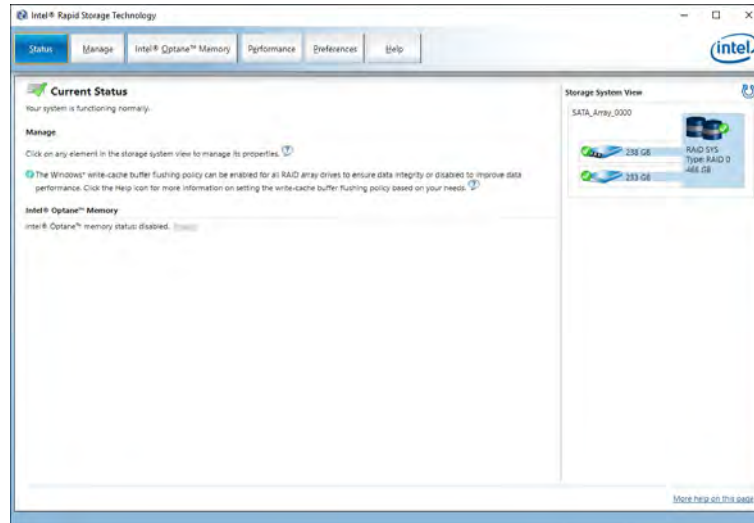

Intel® Rapid Storage Technology Help

If a hard drive member of a RAID volume is reported as “**Degraded**” or “**Failed**” it may be possible to recover the volume. If the volume cannot be restored then you will need to recreate the RAID volume and restore the data from a back up. Click the **Help** menu (or press **F1**) for instructions on how to recover or recreate RAID Volumes.

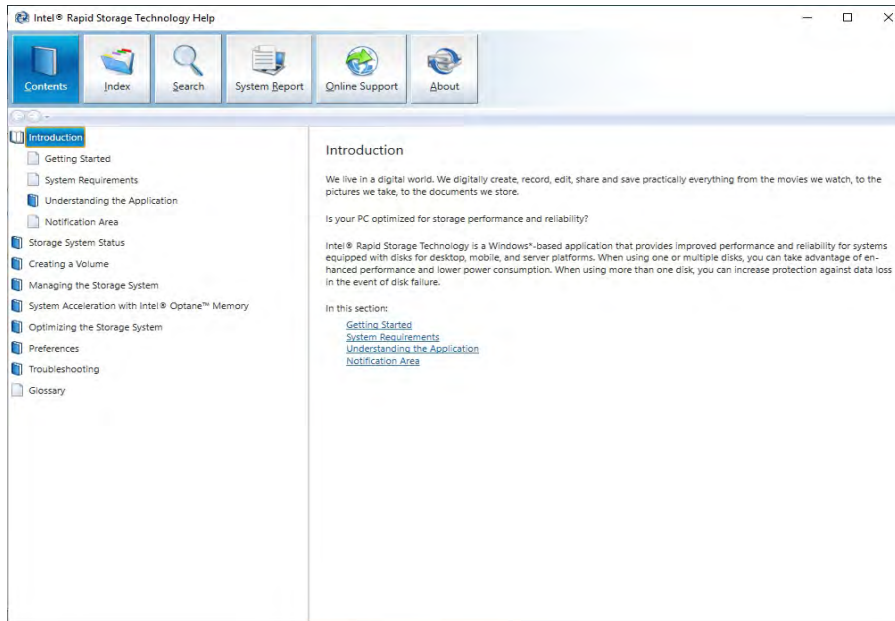

Help

Click the **Help** (or press **F1**) menu button at the top of the **Intel® Rapid Storage Technology** application.

Click **Contents** to view the general list of subjects covered, click **Index** or **Search** for a more specific help topics on a particular item.

Click **More help on this page** at the bottom of any page for page specific help.

Figure 6 - 26
Intel® Rapid Storage Technology Help

RAID Volume Data Verification and Repair

The RAID volume data verification process identifies any inconsistencies or bad data on a RAID 0 or RAID 1 volume. The table outlines what occurs for each RAID level:

Table 6 - 2
RAID Level
Verification &
Repair Status

RAID Level	Verify	Verify & Repair
RAID 0	Bad blocks are identified.	N/A
RAID 1	Bad blocks are identified. Data on the mirrored drive is compared to data on the source drive.	Bad blocks are reassigned. If the data on the mirrored drive does not match the data on the source drive, the data on the mirrored drive is overwritten by the data on the source.

Replacing and Reverting Recovery and Master Volumes

If a master or recovery drive fails you will need to add a new identical drive and rebuild the recovery volume to the drive. You can also revert the master drive to the state of the previous volume update. For details on how to do this see the help file *“Intel® Rapid Storage Technology Help” on page 6 - 41.*

See over for details on how to verify and repair RAID volume data. Verification will identify and repair data inconsistencies on the volume.

Verifying and Repairing RAID Volume Data

1. Run the **Intel® Rapid Storage Technology** application.
2. Click to **select the RAID** in the pane on the right side of the window.
3. Click **Manage** and click **Advanced**.
4. Click **Verify** and click **Verify** (button) to begin the process (in some cases you may be required to **initialize** a volume before verification).

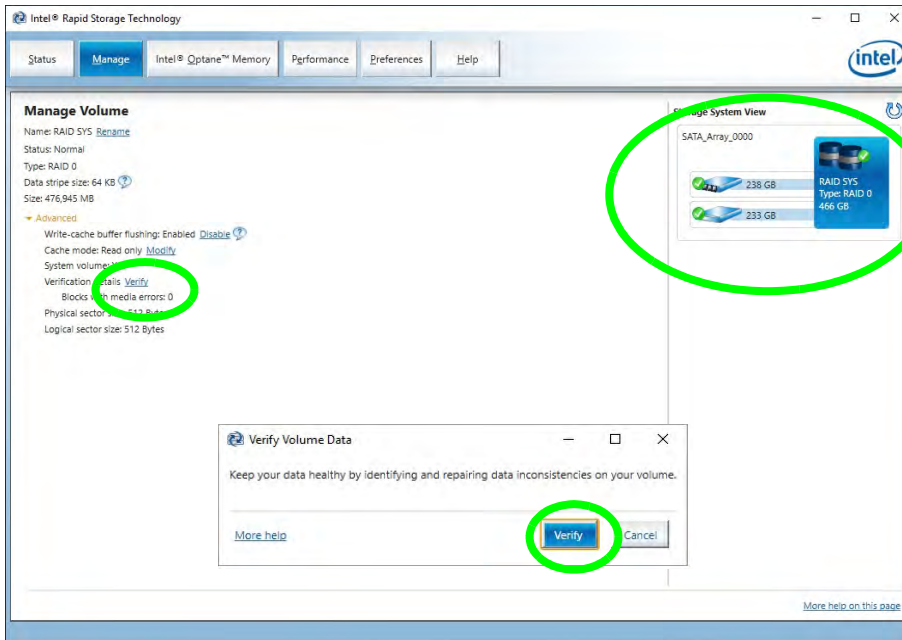

6

Figure 6 - 27
Intel® Rapid Storage Technology Verify

Modules & Options



Scheduling Verify & Repair

You can schedule verification and repair by clicking **Preferences > Scheduler** and enabling a set time for verification and repair.

5. The completion percentage will be listed under **Status** (verifying and repairing).
6. Click **Close** in the Verify Volume Data Results window.

Manage Volume

Name: RAID SYS

Status: Verifying 34% complete [Cancel](#)

Type: RAID 0

Data stripe size: 16 KB [?](#)

Size: 244,204 MB

Advanced

Cache mode: Off

System volume: Yes

Verification details

Verification errors found: 0

Blocks with media errors: 0

Physical sector size: 4096 Bytes

Logical sector size: 512 Bytes

Volume RAID SYS Verification complete.

Verification errors found: 0

[More help](#)

Close

Figure 6 - 28
Intel® Rapid Storage Technology Verify

Intel® Rapid Storage Technology for Optane Systems

Intel® Rapid Storage Technology application displays status information on your Intel® Optane™ configuration. Run the Intel® Rapid Storage Technology application from the item in the Start menu.

When the Intel® Rapid Storage Technology application is launched the system will open the **Status** window. Here you can view the general health of the storage system. Various volume creation and management options are available depending on the system's status.

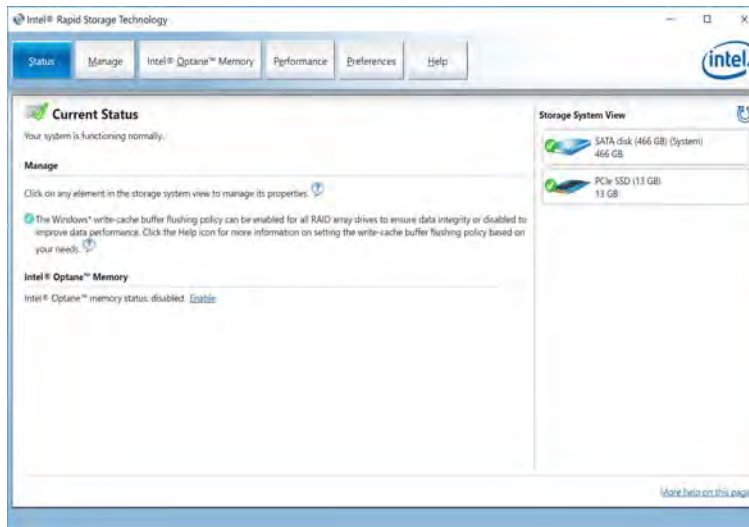
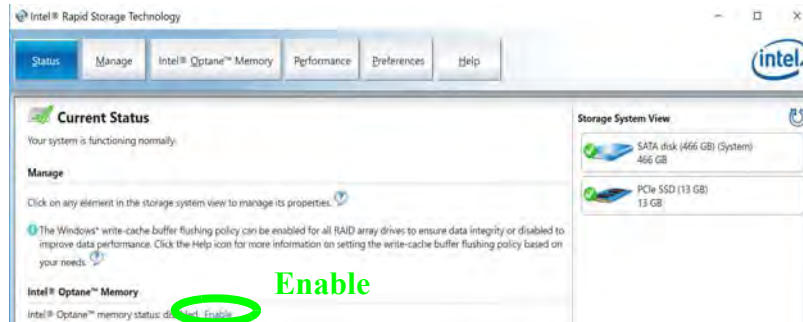

Figure 6 - 29
Intel® Rapid
Storage Technology
Status

Enabling Intel® Optane™

1. Run the **Intel® Rapid Storage Technology** application.
2. Click **Enable**.

Figure 6 - 30
**IRST - Intel®
Optane™ Memory
(Enable)**



3. The system will pop-up a message and ask you to select a compatible fast drive (in this case there should only be one option).

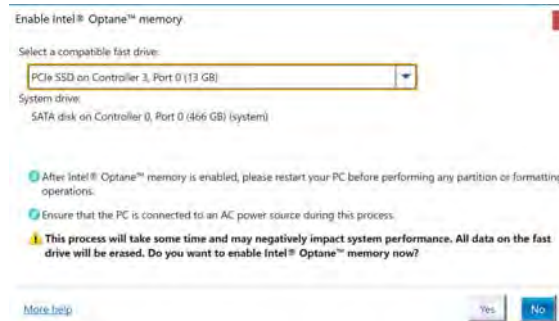

Figure 6 - 31
**IRST - Intel®
Enable Optane™
Memory**

4. You will need to restart the computer after enabling **Optane**, and make sure the system is powered by the powered AC/DC adapter, and not by battery only.
5. Click **Yes** to begin the process (this may take some time).
6. After the process has been completed restart the computer.
7. After restarting can access **Device Manager** (right-click the **Start** menu and select **Device Manager**).
8. Click **Disk drives** to check that the drive should read **Intel Optane *******.

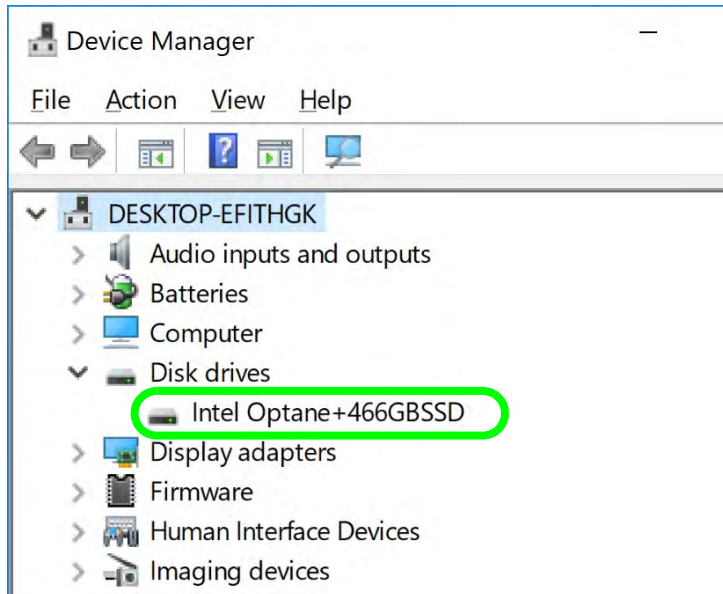

Figure 6 - 32
Device Manager
(Disk drives)

9. Run the **Intel® Rapid Storage Technology** application to check the status.

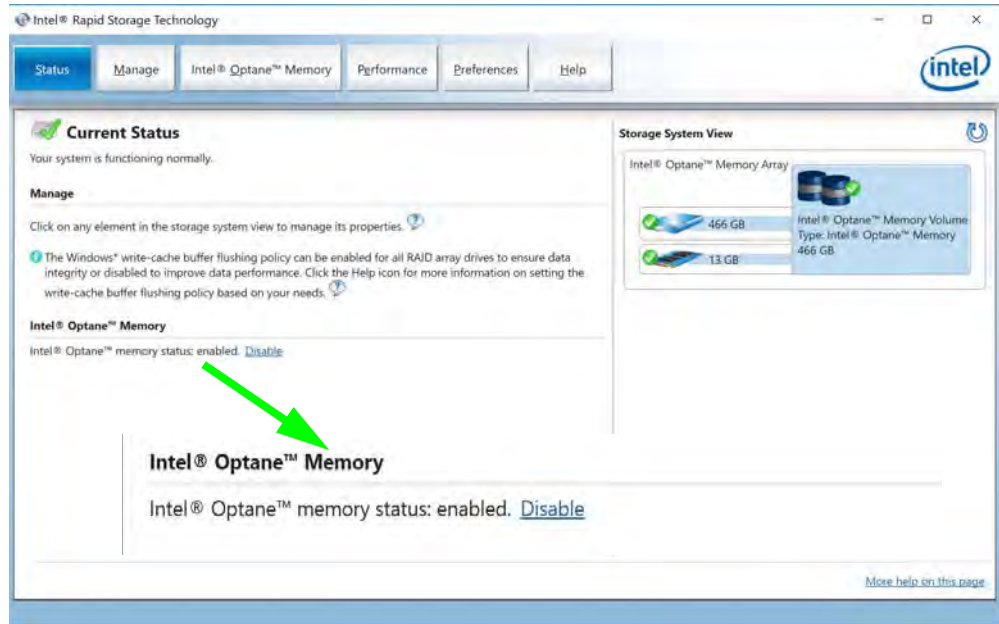
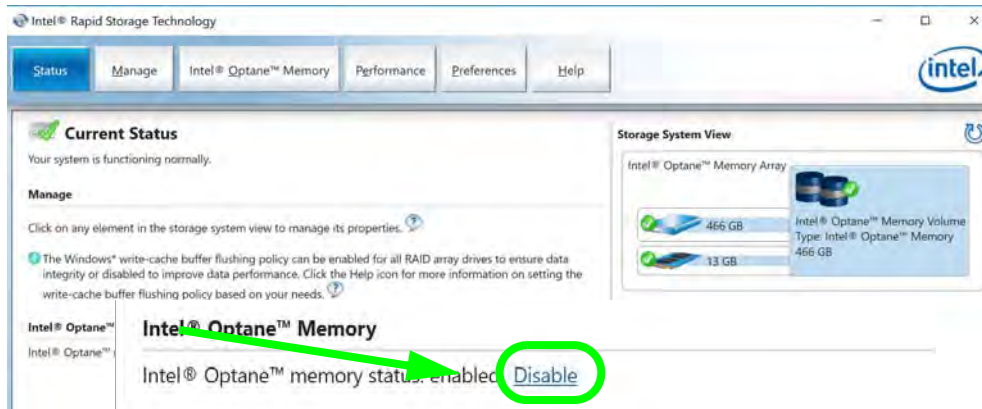

Figure 6 - 33
**IRST - Intel®
Optane™ Memory
(Enabled)**

Disabling Intel® Optane™

If you need to disable **Intel® Optane™** for any reason follow these instructions.

1. Run the **Intel® Rapid Storage Technology** application.
2. Click **Disable**.



3. Click **Yes** when the message pops up.

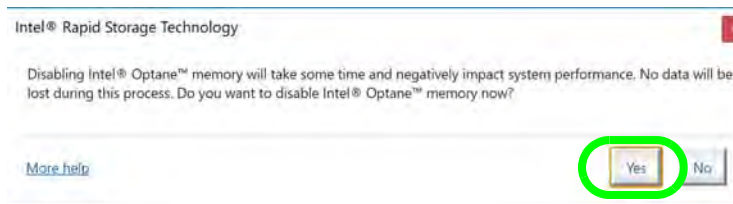



Disabling Intel® Optane™

Disable Intel® Optane™ if you want to reinstall/ reset the system or update the IRST driver. See also *“Disabling Intel® Optane™” on page 6 - 49.*

Figure 6 - 34
IRST - Intel® Optane™ Memory (Disable)

Figure 6 - 35
IRST - Yes to Disable

Modules & Options



HDDs & Intel® Optane™ SSDs

Note that if your system's HDD or Intel® Optane™ SSD is to be transferred to another system for use for any reason, you will need to disable Intel® Optane™ in IRST first.

Removal of any cover(s) and /or screw(s) violates the terms of your warranty.

- Restart the computer to complete the process.
- Run the **Intel® Rapid Storage Technology** application.
- The **Status of Intel® Optane™ Memory** is indicated in the Window.
- To enable **Intel® Optane™ Memory** follow the process indicated in *“Enabling Intel® Optane™” on page 6 - 46.*

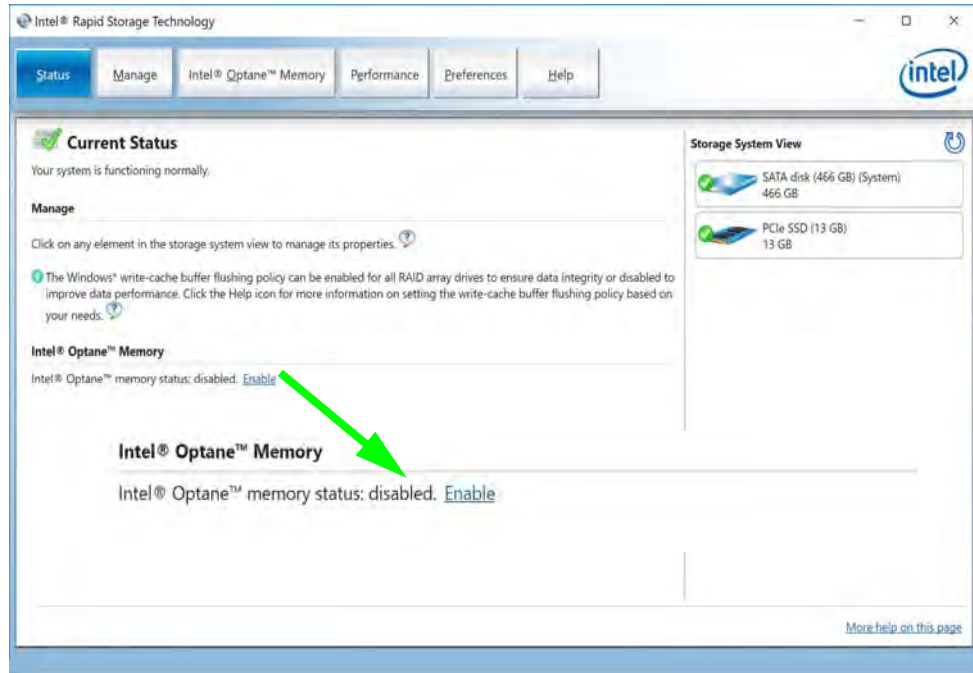



Figure 6 - 36
IRST - Intel® Optane™ Memory (Status)

Sound Blaster Audio

Install the **Sound Blaster Atlas AP** to allow you to configure the audio settings to your requirements for the best performance in games, music and movies.

Sound Blaster Atlas Audio AP Installation

1. Insert the *Device Drivers & Utilities + User's Manual* disc an attached DVD drive.
2. Click **Install Drivers** (button).
1. Click **12.Install Creative Driver > Yes**.
2. Click **OK** to restart the computer.
3. **Sound Blaster Atlas** App will download but you will need to have a working internet connection.
4. Click the **Start** menu in Windows to access the **Microsoft Store App** tile under **Explore**.
5. Click the **Sign in** icon  and select **Downloads and updates**.
6. Click **Check for Updates** and a list of apps being downloaded will pop-up.
7. To prioritize the **Sound Blaster Atlas** driver you can click **Pause all** to pause the download queue.
8. Click on **Sound Blaster Atlas** and click on the resume icon  to download the driver.
9. When just installed the **Sound Blaster Atlas** will appear in the **Windows Start** menu.

Sound Blaster Atlas Application

Run the **Sound Blaster Atlas** control panel from the Start menu in Windows.

Figure 6 - 37
**Sound Blaster
Connect
(Windows Start
Menu)**

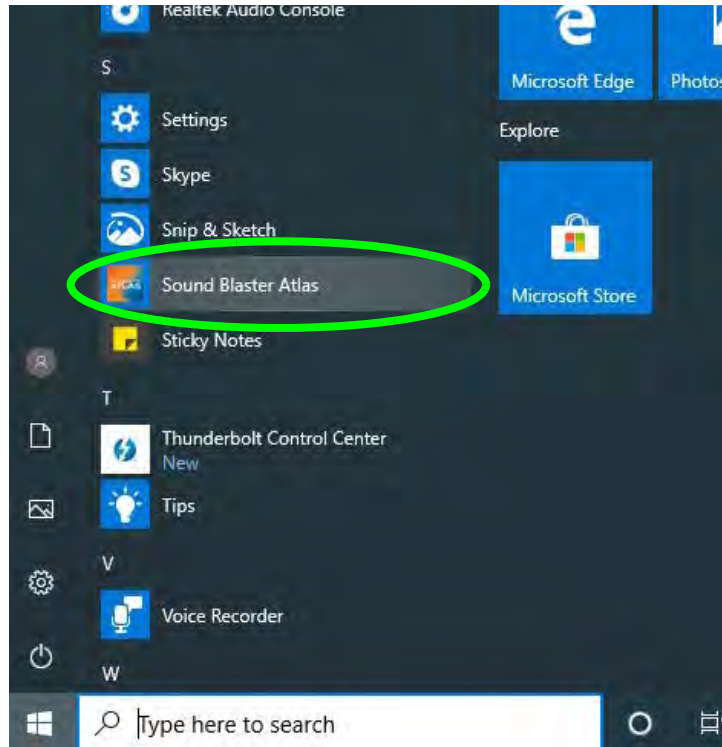

SBX Profile

The **SBX Profile** home **Dashboard** contains a number of preset audio configurations for your use. You can create your own **Profile** settings by clicking the plus icon to create a new profile. Click the output icon  at the bottom left of the screen to select **Headphones** or **Speakers**.

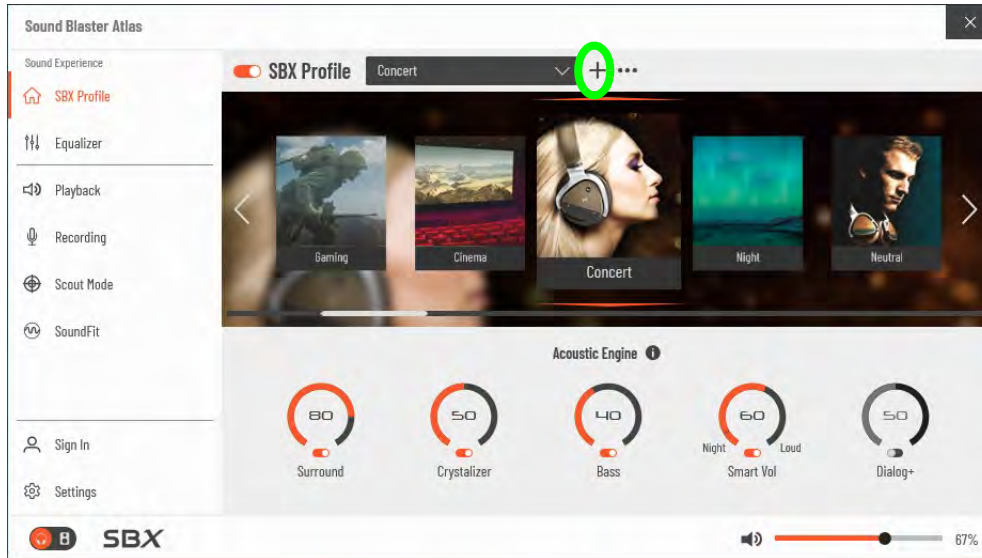

Setup for External Speakers/Headphones

If you find the sound is not balanced when connecting to external speakers/headphones then select a pre-existing setting under Blast Experience e.g Neutral, and test if the balance achieved is better.

It is recommended that you experiment with different settings in order to achieve the best result, and you can adjust any of the settings.

Click on the dotted symbol to the right of the SBX Profile menu and select **Revert** to return to the default settings.

Figure 6 - 38
Sound Blaster Atlas
(SBX Profile)

Modules & Options

The **Acoustic Engine** offers a suite of playback technologies to enhance sound. Each playback technology has an **On/Off button** to allow you to enable/disable it, and most controls feature a dial to adjust the levels.

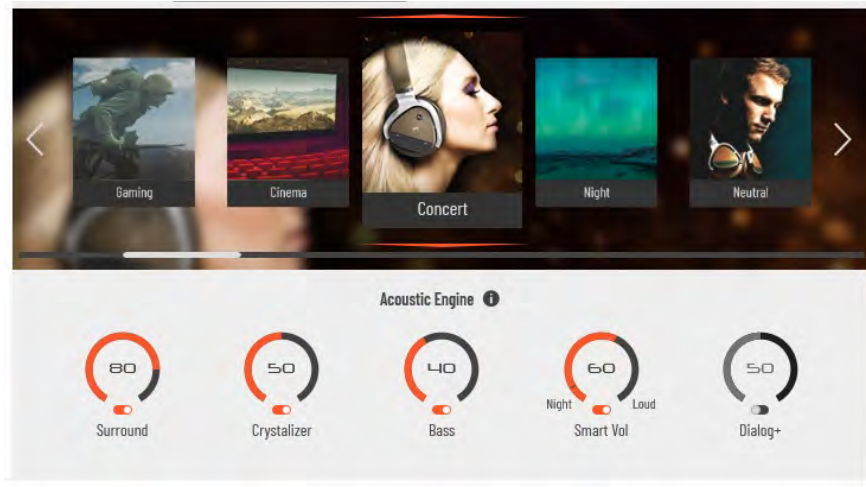

Figure 6 - 39
Sound Blaster Atlas
(Acoustic Engine)

- **Surround:** Provides virtual sound channels to control the level of immersion.
- **Crystalizer:** Enriches audio to make it sound livelier.
- **Bass:** Enhances the bass level of the sound system.
- **Smart Volume:** Minimizes sudden volume changes to avoid the need for constant adjustment.
- **Dialog Plus:** Optimizes dialogue levels for music and movies etc.

Equalizer

The **Equalizer** allows you to manually adjust the **Custom** settings (click **On** to enable the Equalizer).

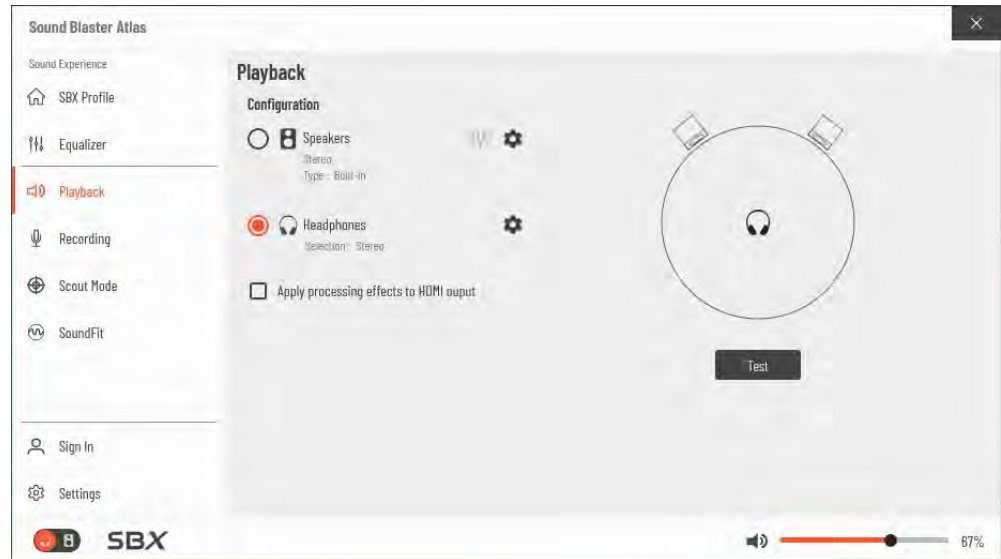

Figure 6 - 40
Sound Blaster Atlas
(Equalizer)

Playback

Playback can be used to **Test** the configuration of the headphones and speakers (click *Apply processing effects to HDMI output* to configure settings for any HDMI connected devices).

Figure 6 - 41
Sound Blaster Atlas
(Playback)



Recording - Voice Morph

These profiles allow you to alter your voice in gaming or online chats.

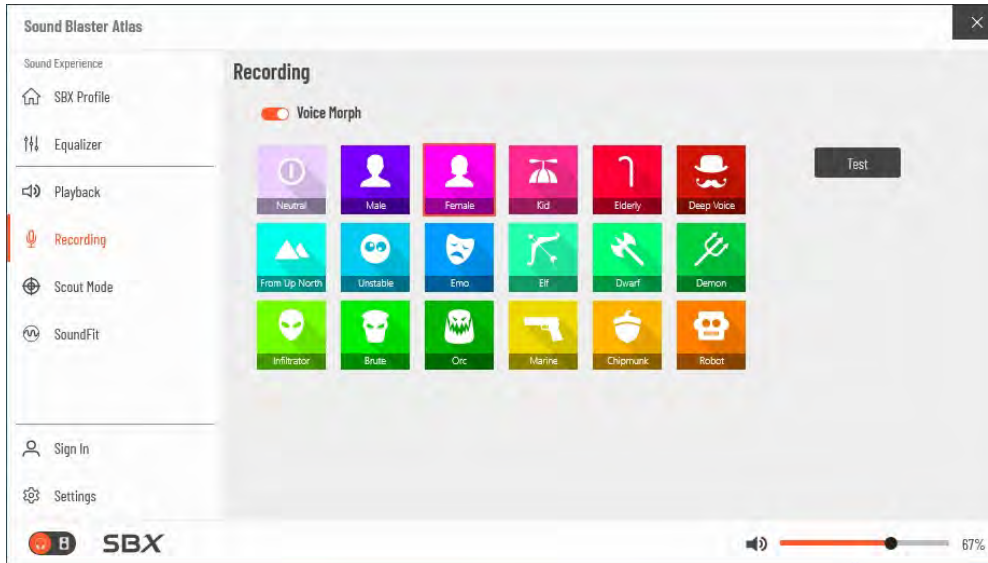
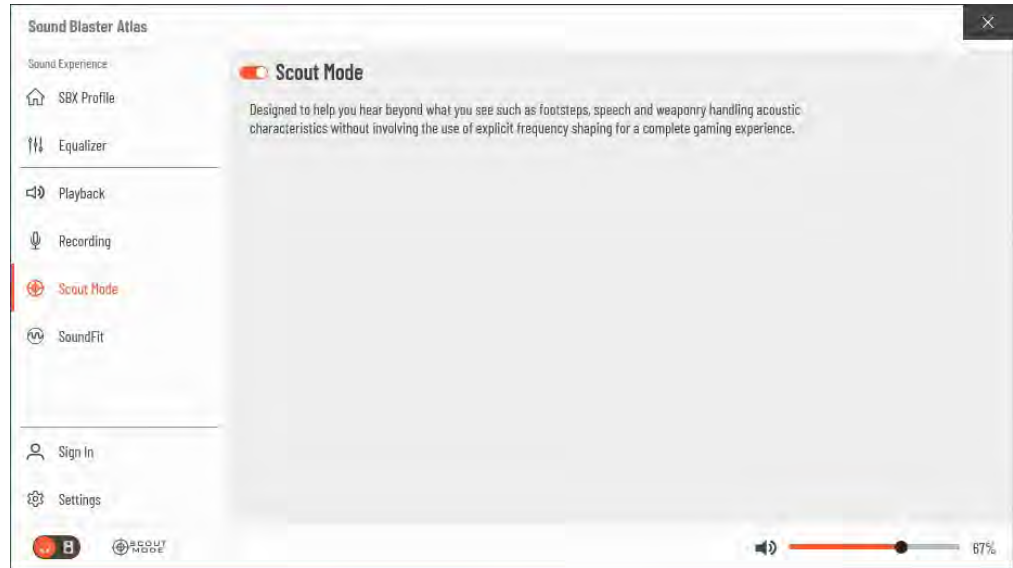

Figure 6 - 42
Sound Blaster Atlas
(Recording - Voice Morph)

Scout Mode

Click on the power button to enable **Scout Mode/Radar** to enhance your ability to hear enemies in games from a further distance away than would normally be possible.

Figure 6 - 43
Sound Blaster Atlas
(Scout Mode)



SoundFit

SoundFit is a feature designed to optimize your headphone output.

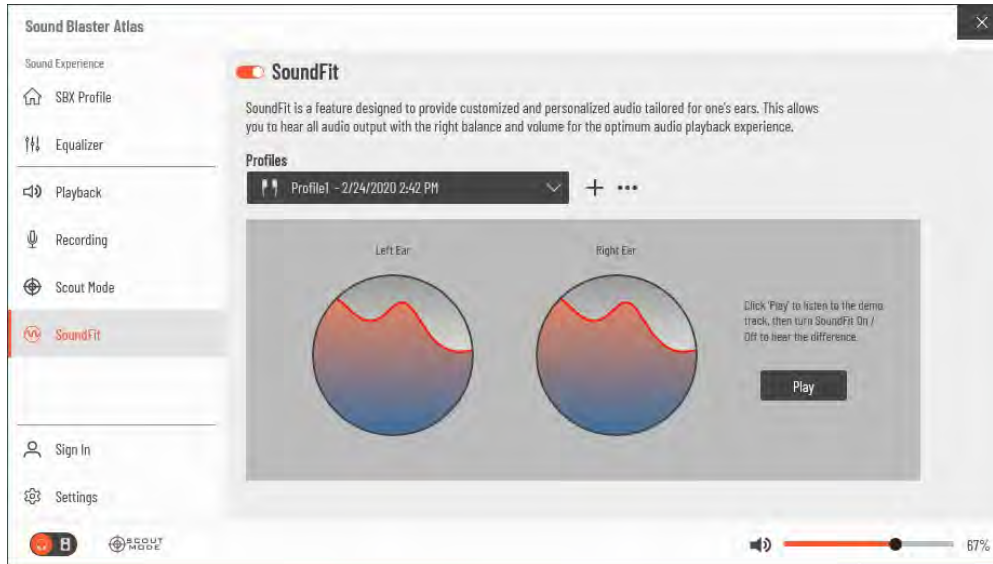
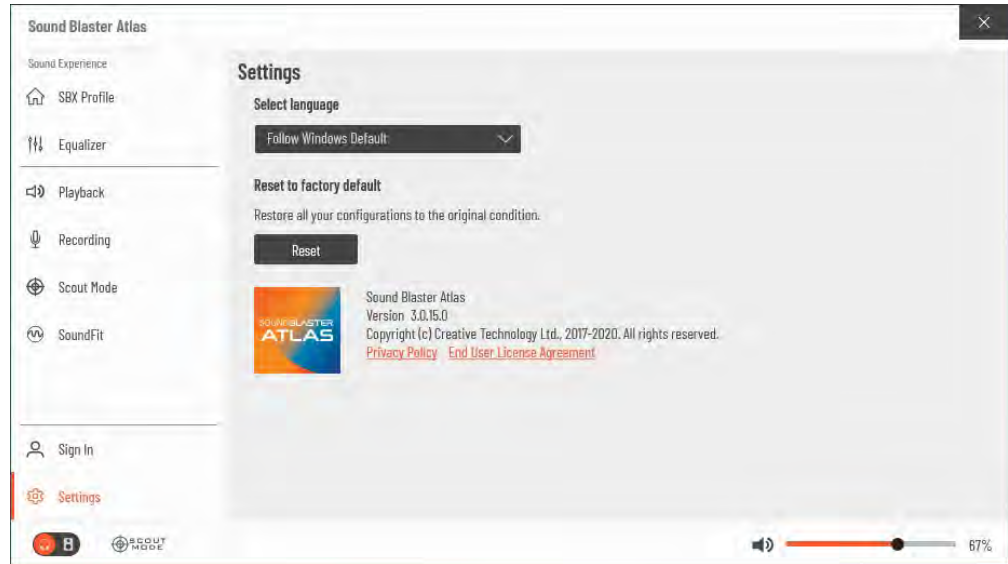

Figure 6 - 44
Sound Blaster Atlas
(SoundFit)

Settings

Settings allows you to set the language preferences. Click **Reset** to return all configurations to the factory default settings.

Figure 6 - 45
Sound Blaster Atlas
(Settings)



PC Camera

When the PC Camera application is run the LED indicator to the left of the camera will be illuminated (see [② Figure 1 - 2 on page 1 - 6](#)/[Figure 1 - 3 on page 1 - 7](#)). Note that you need to use the **Camera** app in *Windows* to take pictures and capture video. Use the **Fn + F10** key combination (see *“Function/Hot Key Indicators” on page 1 - 14*) to toggle power to the PC Camera module.

Note that you need to use the **Camera** app  in *Windows* to take pictures and capture video.

Camera App

1. Make sure the PC Camera is turned on by using the **Fn + F10** key combination (or **Control Center button**).
2. Run the Camera app from the Start menu by clicking on the **Camera** app icon  (you can type “camera” into the search box to find the Camera app).
3. The interface displays two buttons on the right of the screen; one for photo and one for video.

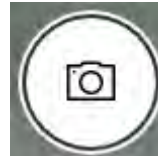

Photo



Video

4. Simply click on the appropriate button (or arrow) to switch to either photo or video modes.
5. You can use the buttons on the left of the screen to access the **Settings, HDR/Brightness** and **Photo Timer**.

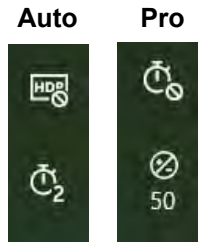

Auto or Pro Modes

The menu buttons displayed on the left side of the screen will depend on the mode chosen in **Settings** . **Pro** mode will display the **timer and brightness** buttons, and with Pro Mode disabled (**Auto mode**) the **timer and HDR** buttons will be displayed.

6
Figure 6 - 46
Camera App Mode Icons

Figure 6 - 47
Camera Menu Buttons

- Click **Settings**  to access the camera settings menu to select/deselect **Pro mode**, make adjustments for **Photo Quality**, **Framing grid**, **Time lapse**, **Video Quality** and **Flicker reduction**.



Camera Settings

The **Self Timer** can be set to take Photos after **2, 5 or 10** seconds.

You can use a **Framing grid** to help you line up pictures.

The **Photo Quality** can be changed to that which the system supports.

Time lapse can be set to keep taking photos until the camera button is pressed again.

The **Video Quality** resolution and frame rate can be set to any supported by the system. Note that capturing high resolution video files requires a substantial amount of disk space for each file. After recording video, check the video file size (right-click the file and select Properties) and the remaining free space on your hard disk (go to File Explorer, right-click the hard disk, and select Properties). If necessary you can remove the recorded video file to a removable medium e.g. a USB Flash drive.

If you need to reduce any screen flicker, change the settings in **Flicker reduction** to either e.g. 50Hz or 60Hz.

Figure 6 - 48
Camera Settings

Modules & Options

7. With the **Pro mode** selected (in Settings ) you can access the **Brightness** button to adjust the brightness.

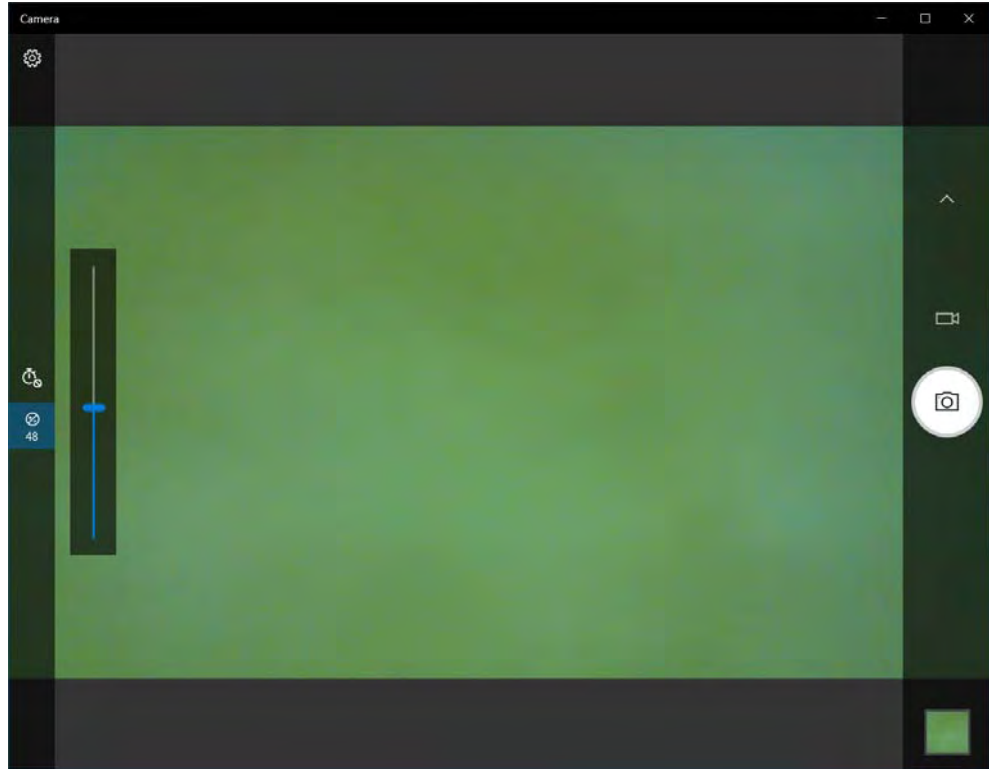

6

Figure 6 - 40
**Camera Brightness
Adjustment
(Pro mode)**

8. In **Auto mode** you can toggle **HDR** on or off.

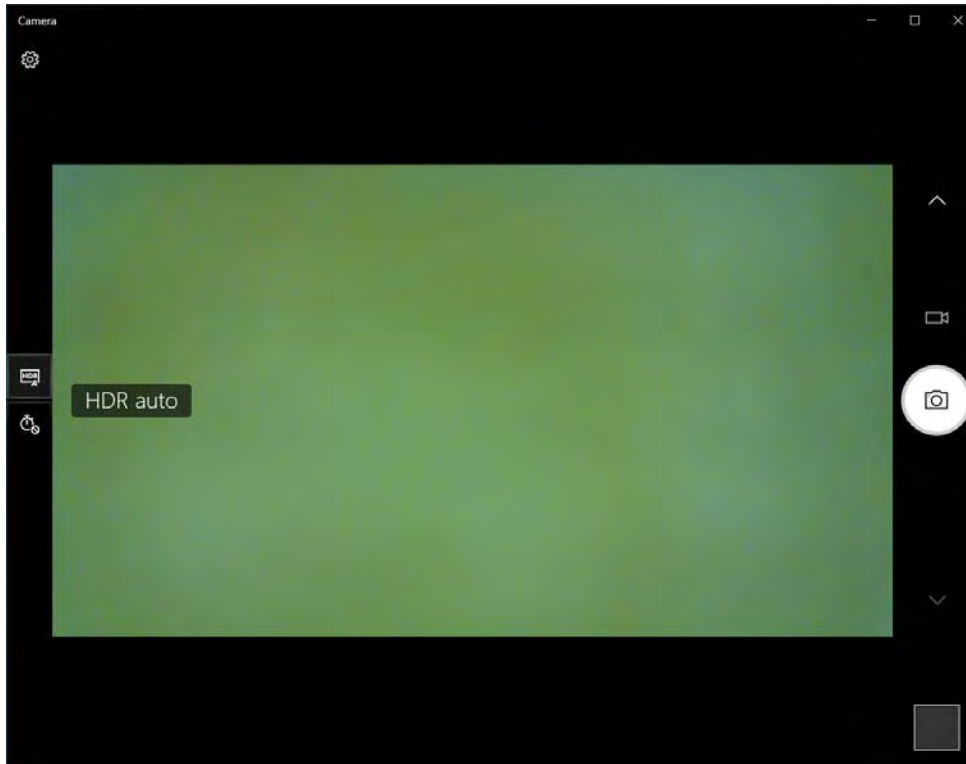







Figure 6 - 51
Camera HDR
(Auto mode)

Taking Pictures/Capturing Video

1. Make sure the PC Camera is turned on by using the **Fn + F10** key combination (or **Control Center button**).
2. Run the Camera app from the Start menu by clicking on the **Camera** app icon  (you can type “camera” into the search box to find the Camera app).
3. Click to select either **photo**  or **video**  modes.
4. Click the photo icon to take a picture.
5. Click on the video icon  to start video capture (when video capture begins a timer will appear at the bottom of the screen).
6. To stop video capture click the stop  button (you can also pause  the video capture).

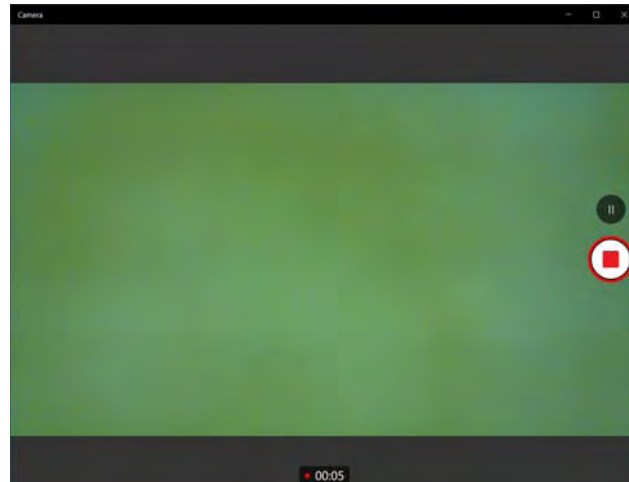

Figure 6 - 52
**Video Camera
Recording in
Process**

- Captured photos and videos will be saved to the **Photos** app stored in the Start menu (type **Photos** into the search box if you cannot find the app). You can also access the photos from the **Camera roll** icon at the bottom right of the Camera app screen.

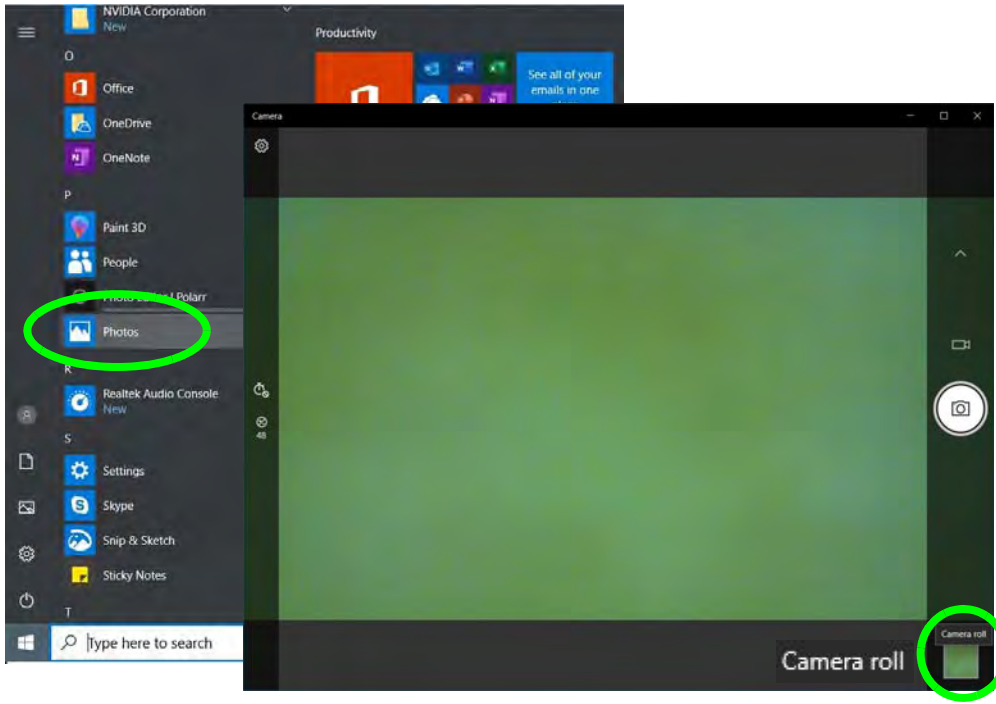

Figure 6 - 53
**Photos App
(For Captured
Photos & Videos)
&
Camera Roll in the
Camera App**

Trusted Platform Module

(Optional)

The **TPM security chip** allows you to create and manage digital certificates for user and platform authentication. This type of security is usually administered within large enterprises and organizations, and therefore requires implementation by a system administrator before users can access security features.

Make sure you have administrator's rights to your computer, and have a *Windows* password enabled for full security protection. In addition **Make sure you prepare a removable media (e.g. a USB flash drive) to store passwords etc. before beginning the TPM initialization process.**

Before setting up the TPM functions you must enable and initialize the security platform.

Enabling & Activating TPM

1. Restart the computer.
2. Enter the **BIOS** pressing **F2** during the POST/startup.
3. Click to enter the **Setup Utility** and select the **Security** menu.
4. Click **TPM Configuration** and select **Enable** for **Security Device Support**.
5. You will then need to save the changes and restart the computer.



Clearing TPM Information

You can click **Clear TPM**, which will toggle the setting between **Enabled/Disabled**. If set to **Enabled** this will clear existing TPM information in order to re-set the TPM.

Figure 6 - 54
Security - Trusted Computing

TPM Management in Windows

You can manage your TPM settings from within *Windows*:

1. Go to the **Control Panel**.
2. Click **BitLocker Drive Encryption (System and Security)**.
3. Click **TPM Administration**.

6

Figure 6 - 55
BitLocker Drive Encryption (TPM Administration)

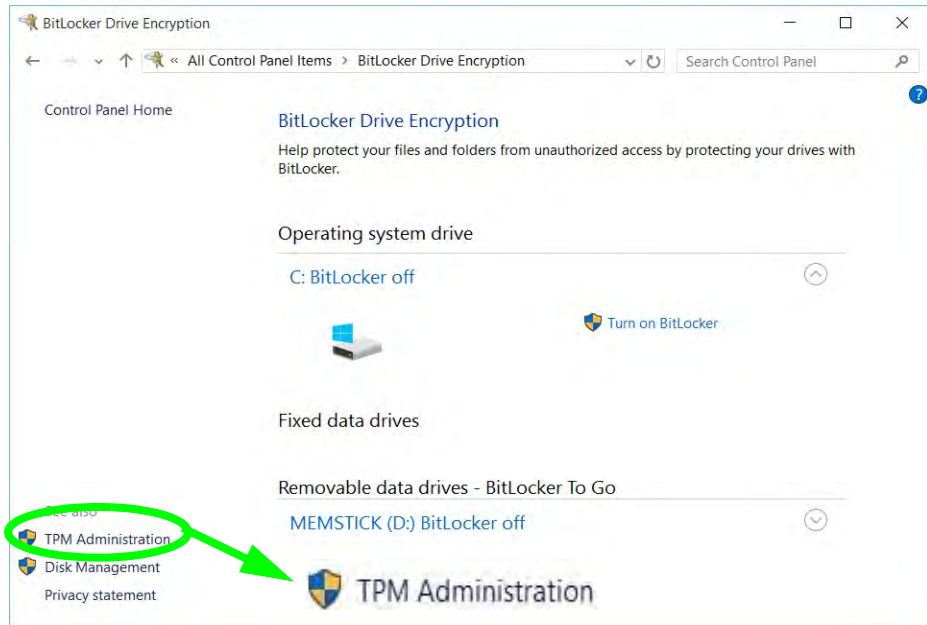

- The TPM Management window allows you to configure the TPM within **Windows**. As TPM is usually administered within large enterprises and organizations, your system administrator will need to assist you in managing the information here.



Figure 6 - 56
**Trusted Platform
 Module (TPM)
 Management on
 Local Computer
 Administration**

TPM Actions

1. Click **Prepare the TPM** and follow the instructions in the Wizard to prepare the TPM (this will probably require a restart of the computer and confirmation of the setting changes after restart by pressing the appropriate F key).
2. After the restart the TPM will be prepared and you can then use the **Actions** menu to **Turn TPM off**, **Change Owner Password**, **Clear TPM** or **Reset TPM Lockout**.
3. A wizard will help take you through any setup steps.

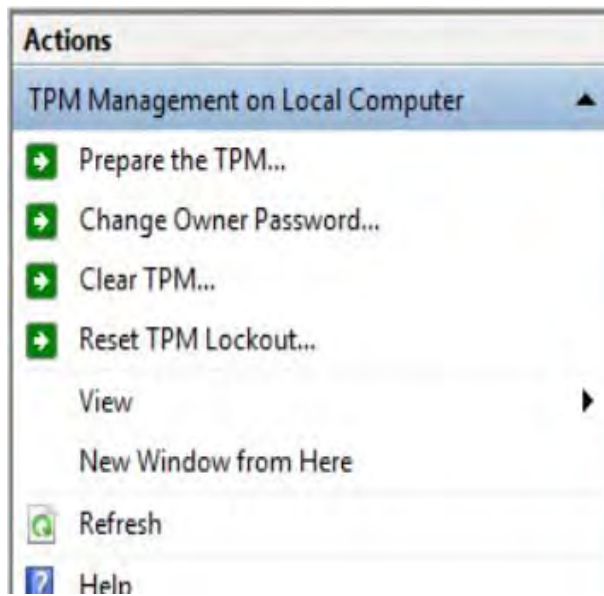

6 *Figure 6 - 57*
TPM Actions Menu

BitLocker

BitLocker Drive Encryption can be used in conjunction with the TPM to encrypt data on the disk. Access the Microsoft **BitLocker Drive Encryption** control panel applet from the *Windows* control panel (**System and Security**).

1. Click **Turn on Bit Locker**.
2. Follow the on-screen instructions to setup BitLocker, and make sure you have a removable media (e.g. a USB flash drive) to store saved recovery keys etc.

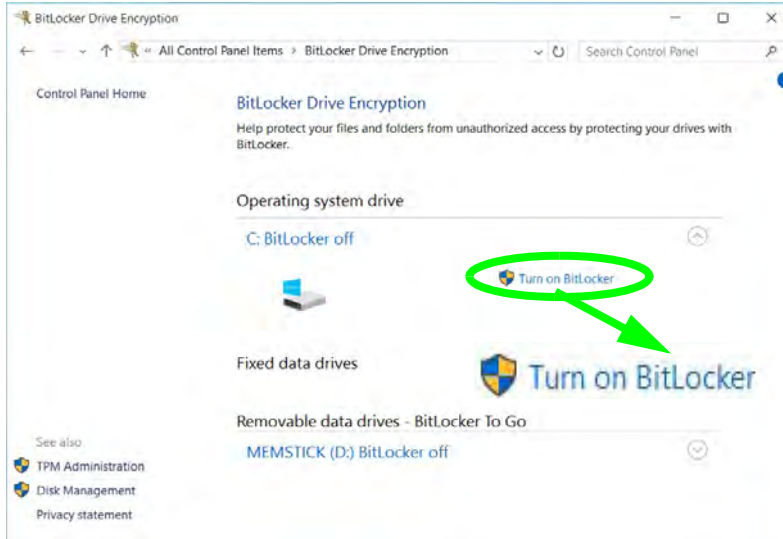

Figure 6 - 58
BitLocker Drive
Encryption

Chapter 7: Troubleshooting

Overview

Should you have any problems with your computer, before consulting your service representative, you may want to try to solve the problem yourself. This chapter lists some common problems and their possible solutions. This can't anticipate every problem, but you should check here before you panic. If you don't find the answer in these pages, make sure you have followed the instructions carefully and observed the safety precautions in the preface. If all else fails, talk to your service representative. You should also make a record of what happened and what remedies you tried.

Of course, if something goes wrong, it will happen at the most inconvenient time possible, so you should preview this section just in case. If, after you've tried everything, and the system still won't cooperate, try turning it off for a few minutes and then rebooting. You will lose any unsaved data, but it may start working again. Then call your service representative.

Basic Hints and Tips

Many of the following may seem obvious but they are often the solution to a problem when your computer appears not to be working.

- **Power** - Is the computer actually plugged into a working electrical outlet? If plugged into a **power strip**, make sure it is actually working. Check the **LED Power & Communication Indicators** (see *“LED Indicators” on page 1 - 10*) to see the computer’s power status.
- **Connections** - Check all the **cables** to make sure that there are no **loose connections** anywhere.
- **Power Savings** - Make sure that the system is not in **Hibernate** or **Sleep** mode by pressing the keys configured in your *Power Options* (see *“Power-Saving States” on page 3 - 7*), the **Fn + F12** key combination, or power button to wake-up the system.
- **Brightness** - Check the brightness of the screen by pressing the **Fn + F8 and F9** keys to adjust the brightness.
- **Display Choice** - Press **Fn + F7** to make sure the system is not set to “external only” display.
- **Boot Drive** - Make sure there are no **optical media and/or USB storage devices** in any connected drive.

Backup and General Maintenance

- Always **backup** your important data, and keep copies of your OS and programs safe, but close to hand. Don't forget to note the **serial numbers** if you are storing them out of their original cases, e.g. in a CD wallet.
- Run **maintenance programs** on your hard disk and OS as often as you can. You may schedule these programs to run at times when you are not using your computer. You can use those that are provided free with your OS, or buy the more powerful dedicated programs to do so.
- Write down your passwords and keep them safe (away from your computer). This is especially important if you choose to use a **Supervisor** password for the BIOS (see *“The Insyde BIOS Utility” on page 5 - 2*).
- Keep copies of vital **settings files** such as network, dialup settings, mail settings etc.(even if just brief notes).



Warranty

The CPU is not a user serviceable part. Opening this compartment, or accessing the CPU in any way, may violate your warranty.

Viruses

- Install an **Anti-Virus** program and keep the **definitions file** (the file which tells your program which viruses to look for) up to date. New computer viruses are discovered daily, and some of them may seriously harm your computer and cause you to lose data. **Anti-Virus** programs are commercially available and the **definitions file updates** are usually downloadable directly from the internet.
- Be careful when opening e-mail from sources you don't know. **Viruses** are often triggered from within **e-mail attachments** so take care when opening any attached file. You can configure most **Anti-Virus** programs to check all **e-mail attachments**. **Note:** You should also beware of files from people you know as the virus may have infected an **address book** and been automatically forwarded without the person's knowledge.
- Keep a "**Bootable CD-ROM/DVD-ROM/USB storage device**" (this CD/DVD/USB device provides basic information which allows you to startup your computer) handy. You may refer to your OS's documentation for instructions on how to make one, and many **Anti-Virus** programs will also provide such a disk (or at least instructions on how to make one).

Upgrading and Adding New Hardware/Software

- Do not be tempted to make changes to your **Windows Registry** unless you are very sure of what you are doing, otherwise you will risk severely damaging your system.
- Don't open your computer or undertake any repair or upgrade work if you are not comfortable with what you are doing.
- Read the **documentation**. We can assume, since you are reading this that you are looking at the computer's manual, but what about any new peripheral devices you have just purchased? Many problems are caused by the installation of new hardware and/or software. Always refer to the documentation of any new hardware and/or software, and pay particular attention to files entitled "**READ ME**" or "**READ ME FIRST**".
- When installing a new device always make sure the device is powered on, and in many cases you will need to restart the computer. Always check that all the cables are correctly connected.
- Make sure you have installed the **drivers** for any new hardware you have installed (latest **driver files** are usually available to download from vendor's websites).

Troubleshooting

- Thoroughly check any **recent changes** you made to your system as these changes may affect one or more system components, or software programs. If possible, go back and undo the change you just made and see if the problem still occurs.
- Don't over complicate things. The less you have to deal with then the easier the source of the problem may be found; **Example** - if your computer has many devices plugged into its ports, and a number of programs running, then it will be difficult to determine the cause of a problem. Try disconnecting all of the devices and restarting the computer with all the peripheral devices unplugged. A process of elimination (adding and removing devices and restarting where necessary) will often find the source of a problem, although this may be time consuming.

Problems and Possible Solutions

Problem	Possible Cause - Solution
You turned on the power but it doesn't work.	<i>Battery missing / incorrectly installed.</i> Check the battery bay, make sure the battery is present and seated properly (the design of the battery only allows it to go in one way). Make sure there's nothing interfering with the battery contacts.
The battery LED power indicator  is blinking orange.	<i>Low Battery.</i> Plug in the DC power source. If the computer doesn't start up immediately, turn it off then on again.
You are losing battery power too quickly.	<i>The system is using too much power.</i> If your OS has a <i>Power Options</i> scheme (see " Power Plans " on page 3 - 5) check its settings. You may also be using a <i>peripheral device/USB device</i> that is drawing a lot of power.
Actual battery operating time is shorter than expected.	<p><i>The battery has not been fully discharged before being recharged.</i> Make sure the battery is fully discharged and recharge it completely before reusing (see page 3 - 21).</p> <p><i>Power Options have been disabled.</i> Go to the Control Panel in <i>Windows</i> and re-enable the options.</p> <p><i>A peripheral device/USB device is consuming a lot of power.</i> Turn off/remove the unused device to save power.</p>
The system will not start up when it is being operated in a low temperature environment .	This is due to the electrical characteristics of battery cells at low temperatures. Although the lowest operational temperature tolerance of the system is listed at 5°C, however if the system is in DC mode (on battery), the battery must have a remaining charge capacity of 60%+; at 10°C or above.

Troubleshooting

Problem	Possible Cause - Solution
<p>The system will not wake up from a power saving state (Sleep/Hibernate) on network activity (Wake on LAN) even though I have plugged in the powered AC/DC adapter.</p>	<p><i>Wake on LAN is supported in AC mode only.</i></p> <p>When the system enters a power saving state the plugged in AC/DC adapter should be connected, and should remain connected, in order to allow the system to wake up on network activity. Unplugging the adapter, and then plugging it back in again, will not allow the system to wake up on network activity.</p>
<p>The computer feels too hot.</p>	<p>Make sure the computer is properly ventilated and the Vent/Fan intakes are not blocked. If this doesn't cool it down, put the system into Hibernate mode or turn it off for an hour. Make sure the computer isn't sitting on a thermal surface (see “Overheating” on page 1 - 21/1 - 22). Make sure you're using the correct adapter.</p> <p>Make sure that your notebook is completely powered off before putting it into a travel bag (or any such container). Putting a notebook which is powered on in a travel bag may cause the Vent/Fan intakes to be blocked.</p>
<p>When playing a video in Media Player, while using a 4K panel, the counting timer area at the bottom of the screen appears to be cut off slightly.</p>	<p><i>The size of text, apps and other items in Settings > System > Display is set to 250%. In this case it is recommended that the setting should be less than 250%.</i></p>
<p>When you are playing a game and you use the Windows Key to switch to the desktop an error message, or Blue Screen, occurs.</p>	<p><i>This is a DirectX compatibility issue. In this case disable DirectX from within the game controls.</i></p>

Problem	Possible Cause - Solution
<p>Nothing appears on screen.</p>	<p><i>The system is in a power saving mode.</i> Toggle the sleep/resume key combination, Fn + F12 (see “Configuring the Power Buttons” on page 3 - 9).</p> <p><i>The screen controls need to be adjusted.</i> Toggle the screen control key combinations Fn + F8/F9. If you’re connected to an external monitor, make sure it’s plugged in and turned on. You should also check the monitor’s own brightness and contrast controls.</p> <p><i>The computer is set for a different display.</i> Toggle the screen display key combination, Fn + F7. If an external monitor is connected, turn it on.</p> <p><i>The screen saver is activated.</i> Press any key or touch the TouchPad.</p>
<p>No image appears on the external monitor I have plugged in and powered on.</p>	<p><i>You haven’t installed the video driver and configured it appropriately from the Control Panel.</i> See Appendix C for instructions on installing and configuring the video driver.</p>
<p>You forget the boot password.</p>	<p><i>If you forget the password, you may have to discharge the battery of the CMOS.</i> Contact your service representative for help.</p>
<div style="text-align: center;">  <p>Password Warning</p> <p>If you choose to set a boot password, NEVER forget your password. The consequences of this could be serious. If you cannot remember your boot password you must contact your vendor and you may lose all of the information on your hard disk.</p> </div>	

Troubleshooting

Problem	Possible Cause - Solution
The sound cannot be heard or the volume is very low .	<i>The volume might be set too low. Check the volume control in the Volume Control Panel in the Windows notification area, or use the key combination Fn + F5 and F6 (see “Function/Hot Key Indicators” on page 1 - 14) to adjust.</i>
My internal microphone seems to be disabled and/or I can still hear sound from the speakers even though I have plugged headphones into the headphone jack.	<i>“Enable jack detection when device is plugged in” is disabled in Connector Settings (Device advanced settings) in the Realtek Audio Console control panel. Go to the Realtek Audio Console control panel and click Device advanced settings and make sure that “Enable jack detection when device is plugged in” is On.</i>
Unwelcome numbers appear when typing.	<i>Num Lock is turned ON (see “Function/Hot Key Indicators” on page 1 - 14).</i>
I am sliding my finger up and down on the right side of the Touchpad to scroll a Window and the Touchpad does not respond .	<i>There are different Touchpad versions available on this computer, and this version requires tapping/holding to scroll. Either tap repeatedly, or hold the finger down, at the top or bottom right of the Touchpad (depending on the scrolling direction required) to scroll the window.</i>
 <p>Other Keyboards</p> <p>If your keyboard is damaged or you just want to make a change, you can use any standard USB keyboard. The system will detect and enable it automatically. However special functions/hot keys unique to the system’s regular keyboard may not work.</p>	



Problem	Possible Cause - Solution
The system freezes or the screen goes dark.	<i>The system's power saving features have timed-out.</i> Use the AC/DC adapter, press the sleep (Fn + F12) key combination, or press the power button if no LEDs are lit.
The system never goes into a power saving mode .	Power Options features are not enabled. Go to the Windows Power Options menu and enable the features you prefer (see "Power-Saving States" on page 3 - 7). Make sure you have enabled Hibernate mode from the control panel.
The computer is off (or in Sleep Mode) but powered by the AC/DC adapter plugged in to a working outlet, or by battery with a capacity above 20%. I have plugged a device into the powered USB port in order to charge it, but the device is not charging .	<p><i>The port is not powered on.</i> Toggle power to the port using the Fn + power button combination.</p> <p><i>This function may not work with certain external USB compliant devices (check your device's documentation).</i> If this is the case, power the computer on and connect the external USB device in order to charge it.</p> <p>Note that this function is designed to help charge USB compliant devices, but is not designed to allow their operation.</p>
The Wireless LAN/Bluetooth modules cannot be detected.	<i>The modules are off as the computer is in Airplane Mode.</i> Go to the Charms Bar and select Settings and then click the WiFi icon (Airplane mode should be Off).
The PC Camera module cannot be detected.	<i>The module is off.</i> Press the Fn + F10 key combination in order to enable the module (see "Function/Hot Key Indicators" on page 1 - 14). Run the camera application to view the camera picture.

Troubleshooting

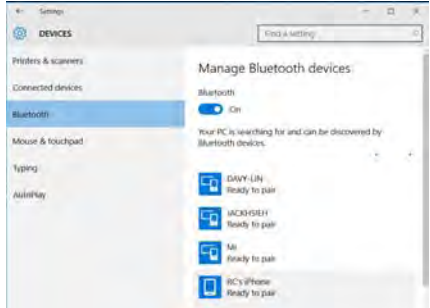
Problem	Possible Cause - Solution
The Wireless LAN/Bluetooth modules cannot be configured.	The driver(s) for the module(s) have not been installed. Make sure you have installed the driver for the appropriate module (see the instructions for the appropriate module in <i>“Modules & Options” on page 6 - 1</i>).
A file cannot be copied to/from a connected Bluetooth device.	<i>The transfer of data between the computer and a Bluetooth enabled device is supported in one direction only (simultaneous data transfer is not supported). If you are copying a file from your computer to a Bluetooth enabled device, you will not be able to copy a file from the Bluetooth enabled device to your computer until the file transfer process has been completed</i>
No sound can be heard through an HDMI connected display.	<i>You have not configured the HDMI audio output. See “HDMI Audio Configuration” on page C - 9.</i>
The fingerprint reader has problems scanning fingers .	<i>When fingers are wet or sweaty the software application may have difficulty reading a scanned finger. Make sure your fingers are clean and dry when attempting to scan them on the sensor for detection.</i>
At the Windows Hello screen, the Fingerprint reader fails to recognize the fingerprint 3 times and blocks access to the computer .	In this case you will need to use your PIN (the PIN you used when initially setting up the fingerprint reader) to access the computer . Alternatively you can sign-in using your windows password. After using the PIN code (or windows Password) to access the computer you can go to the Settings > Accounts > Sign-in options if you wish to change any settings.
Gaming performance is slow.	<i>It is recommended that you use Maximum fan speed when playing games.</i> Use the Fn + 1 key combination to adjust the fan speed.

Problem	Possible Cause - Solution
<p>When using a Bluetooth headset the audio appears to be mono and not stereo.</p>	<p><i>This is a common issue with Bluetooth headsets. To resolve this issue do the following (you will need to repeat this procedure after every boot up, restart, or when the system resumes from hibernation):</i></p> <ol style="list-style-type: none"> 1. Go to the Devices & Printers control panel in Windows. 2. Double-click the Bluetooth headset. 3. Click Connect to complete the stereo connection. <p>OR</p> <ol style="list-style-type: none"> 1. Go to the Sound control panel in Windows. 2. Right-click (in the Playback tab) the Bluetooth Stereo Audio device (the default device is Headset). 3. Click Connect to complete the stereo connection.
<p>A file being copied to/from a connected Bluetooth device appears to be transferring very slowly.</p>	<p>You may have the Bluetooth control panel (Settings > Devices > Bluetooth) open. When transferring data between the computer and a Bluetooth enabled device, make sure that the Bluetooth control panel is closed.</p> <div data-bbox="608 669 1027 986" style="border: 2px solid red; border-radius: 20px; padding: 10px; text-align: center; color: white; margin: 10px 0;">  <p>Bluetooth Control Panel (Settings > Devices)</p> <p>Close the Bluetooth control panel (pictured on the right) when transferring data between the computer and a Bluetooth enabled device.</p> </div> 

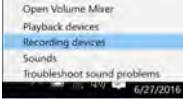
Troubleshooting

Problem	Possible Cause - Solution
<p>I can't hear any sound from the microphone in my connected headset, when trying to test the audio playback.</p>	<p>You need to enable listening to the microphone in the audio control panel in order to hear any sound through your connected headset as follows:</p> <ol style="list-style-type: none"> 1. Right-click the volume control icon  in the taskbar. 2. Select Recording Devices.  3. Double-click Microphone and select Listen. 4. Click to put a check in Listen to this device check box.  5. Click Apply. 6. You can then listen to the playback though the headset for testing. 7. Remember to disable this feature (remove the check from the Listen to this device check box) otherwise you may hear an echo from the internal microphone when you disconnect the headset.

Intel® Optane™ Notes

Intel® Optane™ is a combination of a compatible memory device and Intel Rapid Technology software. This combination is designed to speed up your system performance. However note the following;

- The **SATA Mode** should be set **BEFORE installing an operating system**, and after you have backed up all necessary files and data (see sidebar). See *“SATA Mode Setup (Optane™, RAID or AHCI)” on page 6 - 2* for details. Make sure you install the **Intel Rapid Storage Technology application** if you have set the SATA Mode to **Intel RST Premium**, or to **AHCI** (see *“IRST Driver Installation” on page 6 - 33*).
- It is very important to make sure that when you create a hard disk drive partition when installing Windows for an **Intel® Optane™** system, that you leave at least a minimum of 5MB of unallocated space (note this is 5MB only, not GB).
- **After setting the SATA mode to Intel® Optane™** and installing the Intel® Rapid Storage Technology application, **DO NOT uninstall the Intel® Rapid Storage Technology application**.
- If you are reinstalling a system that has previously been setup in **Intel RST Premium mode**, **make sure you have disabled the Intel Optane Memory** (see *“Disabling Intel® Optane™” on page 6 - 49*). If you haven't cleared the Optane setup you may not find a suitable hard disk drive partition on which to reinstall an operating system.
- If you need to reinstall an operating system, uninstall the IRST driver/application or swap the hard disk drive (or Intel® Optane™ SSD) **make sure you have disabled the Intel Optane Memory** (see *“Disabling Intel® Optane™” on page 6 - 49*).

OLED Screen Information

For the long term care of, and display quality on, OLED screens note the following:





- It is highly recommended that you enable “Automatically hide the taskbar in desktop mode” (Settings > Personalization > Taskbar).
- Use the Power & sleep Settings to turn off the screen after a short period of inactivity.
- Use a medium level of brightness.
- Use a screensaver (specific pieces of motion content designed to combat burn-in) application.
- Change the screen background picture from time to time (and the Lock Screen picture in Personalization settings).

Appendix A: Interface (Ports & Jacks)





Overview

The following chapter will give a quick description of the interface (ports & jacks) which allow your computer to communicate with external devices, connect to the internet etc.



Ports and Jacks

Item	Description
<p>2-In-1 Audio Jacks Headphone/Microphone</p>  <p>Microphone / S/PDIF-Out</p> 	<p>Headphone / Microphone Headphones or speakers may be connected through this jack. Note: Set your system's volume to a reduced level before connecting to this jack. Plug an external microphone in to this jack to record, or use a communication device, on your computer.</p> <p>Microphone / S/PDIF-Out In addition to being a microphone jack this jack also functions as a S/PDIF (Sony/Philips Digital Interface Format) Out port allowing you to connect your DVD-capable PC to a Dolby AC-3 compatible receiver for "5.1" or 'dts' surround sound.</p>
<p>Micro SD Push-Push Card Reader</p> 	<p>The card reader allows you to use some of the latest microSD digital storage cards. Push the card into the slot and it will appear as a removable device. The compatible microSD card formats are listed below:</p> <ul style="list-style-type: none"> • microSD / microSDHC / microSDXC (Up to UHS-II)
<p>DC-In Jack</p> 	<p>Plug the supplied AC/DC adapter into this jack to power your computer.</p>



A

Item	Description
HDMI-Out Port 	The HDMI-Out (High-Definition Multimedia Interface) is an audio/video connector interface for transmitting uncompressed digital streams. This allows you to connect an external monitor, TV or Flat Panel Display etc. as a display device by means of a HDMI cable. Note that HDMI carries both audio and video signals.
Mini DisplayPort 1.4 	The Mini DisplayPorts are miniaturized versions of the DisplayPort, which is a digital display interface standard that allows a digital audio/video interconnect, between the computer and its external display or a home-theater system. <div data-bbox="432 456 1453 645" style="border: 2px solid red; border-radius: 15px; padding: 10px; text-align: center; margin-top: 10px;">  <p>Mini DisplayPort Cables</p> <p>When using cables connected to the Mini DisplayPort, try to make sure that the cables are not bent excessively, as bending the cables may cause signal problems.</p> </div>
RJ-45 LAN Jack 	This port supports LAN (Network) functions (you will need to open the cover slightly before inserting a LAN cable). Note: Broadband (e.g. ADSL) modems usually connect to the LAN port.
Security Lock Slot 	To prevent possible theft, a Kensington-type lock can be attached to this slot. Locks can be purchased at any computer store.

Interface (Ports & Jacks)

Item	Description
<p>Thunderbolt™ 3 Port</p> 	<p>This Thunderbolt 3 port allows for the connection of external peripherals to the computer by combining PCI Express (PCIe), DisplayPort (DP), USB 3.2 and its own Thunderbolt 3 technologies. Up to seven peripherals may be supported by one connector by daisy-chaining the devices. Devices supported include HDDs/SSDs, Audio Interfaces, docks, display devices, cameras, network cables etc.</p> <p>Install the driver as instructed in “Thunderbolt Port Driver” on page 6 - 30. This will install the Thunderbolt software to your computer, and this can be accessed by clicking or double-clicking the Thunderbolt Control Center  Thunderbolt Control Center in the Start menu.</p> <p>The security level configuration for the Thunderbolt port can be set up in the BIOS (see “Security Level (Advanced Menu > Thunderbolt(TM) Configuration)” on page 5 - 18).</p> <div data-bbox="424 564 1458 925" style="border: 2px solid red; border-radius: 15px; padding: 10px;"><p style="text-align: center;"> Thunderbolt Port Devices</p><p>When plugging a device into a Thunderbolt port allow 30 seconds for the system to scan and recognize the connected device. In order to prevent system problems make sure you do not simply pull the cable out from the Thunderbolt port. The hardware must be ejected safely:</p><ol style="list-style-type: none">1. Go to the notification area of the taskbar and click on the Safely Remove Hardware and Eject Media icon.2. Click on Eject <i>“Thunderbolt Device Name”</i>.3. When you see the “Safe to Remove Hardware” message you can remove the cable after about 20 seconds, to make sure that it is safe to eject the device.</div>

A

Item	Description
<p data-bbox="140 227 384 281">USB 3.2 Gen 1 Type A Ports</p>  <p data-bbox="129 359 395 413">Powered USB 3.2 Gen 1 Type A Port</p> 	<p data-bbox="427 227 1461 370">These USB ports are for low-speed peripherals such as keyboards, mice or scanners, and for high-speed peripherals such as external HDDs, digital video cameras or high-speed scanners etc. Devices can be plugged into the computer, and unplugged from the computer, without the need to turn the system off (if the power rating of your USB device is 500mA or above, make sure you use the power supply which comes with the device).</p> <p data-bbox="427 385 1461 439">USB sports capable of 5Gbps (SuperSpeed) are classified as USB 3.2 Gen 1. There are three USB 3.2 Gen 1 (Type A) ports on this computer model, including a powered USB port.</p> <p data-bbox="427 465 1461 636">Note: The powered USB 3.2 Gen 1 port may be toggled on /off by means of the Fn + Power Button key combination. When the powered USB port is on it will supply power (for charging devices only, not for operating devices) when the system is off but still powered by the AC/DC adapter plugged into a working outlet, or powered by the battery with a capacity level above 20% (this may not work with certain devices - see page 7 - 11). Toggle power to this port by using Fn + power button.</p> <p data-bbox="427 663 1461 716">Note: This function is designed to help charge USB compliant devices, but is not designed to allow their operation.</p> <p data-bbox="427 743 1461 797">Note: The maximum amount of current supplied by USB Type-C ports is 500 mA for USB2.0/900 mA for USB 3.2.</p>

Interface (Ports & Jacks)

A

Appendix B: Control Center

Overview

The following chapter will give a quick description of the functions of the **Control Center & Flexikey®** applications.

Control Center

The **Control Center** provides quick access to **Power Modes**, **Fan** settings, **LED Keyboard** configuration and the Flexikey application. Click icons to access the appropriate menu, and make adjustments as applicable.

Flexikey®

The **Flexikey®** application is a quick hotkey configuration application, which allows you to **assign a single key to launch multiple key combinations**, to **create text macros** and to **disable** certain keys. The application can also be used to **configure the mouse buttons** to create hotkeys for gaming etc. Click **Flexikey** in the Control Center to launch the application.

Control Center

Run the **Control Center** from the **Windows Start menu**

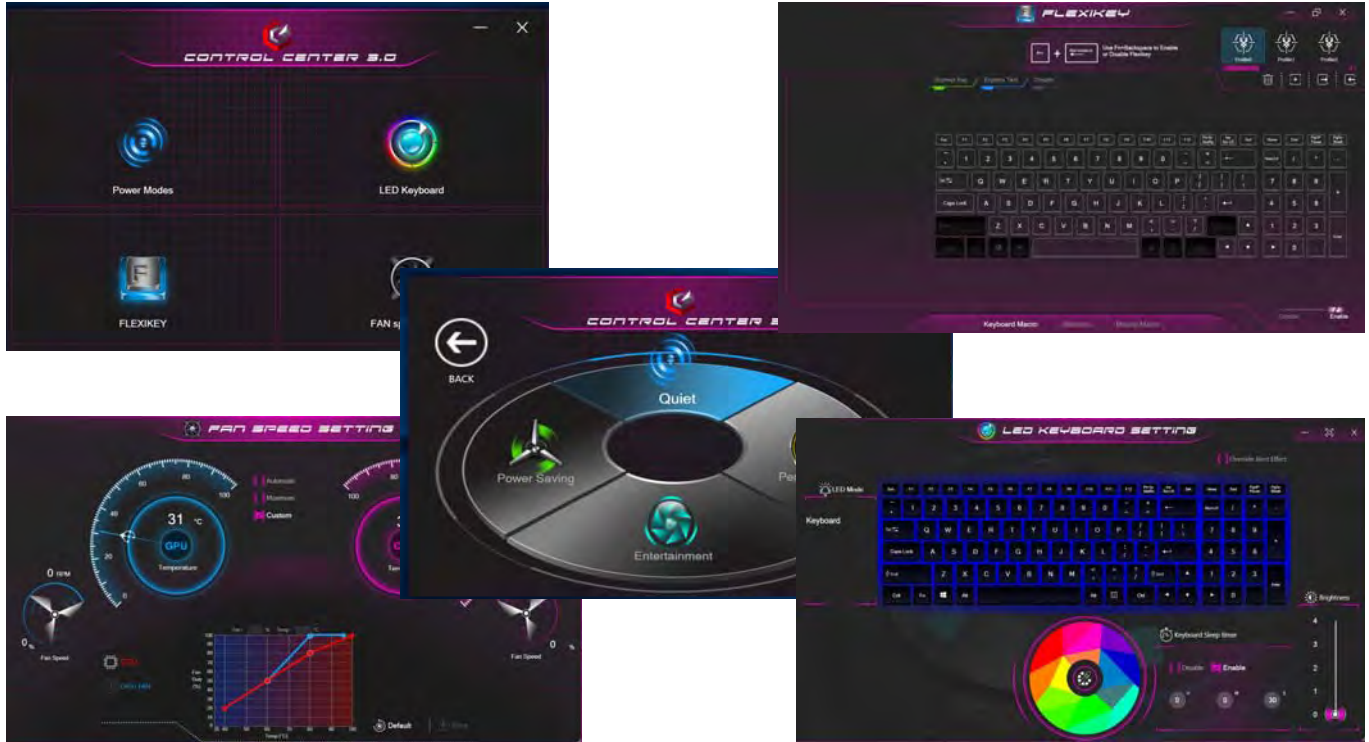
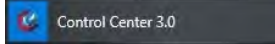
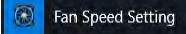

Figure B - 1 - Control Center & FlexiKey

B - 2 Overview

Fan Speed Setting

You can access the **Fan Speed Setting** from the **Control Center** or the **Windows Start menu** . Set the fan speed to **Maximum (full power)**, **Automatic** or **Custom** from this menu item. The fan speed will adjust itself automatically to control the heat of the CPU. However you can adjust the setting to maximum if you prefer. You can use the **Offset** slider to adjust the settings to your preference, however these settings can be overridden by the system as a safety precaution, if it requires heavier use of the fan.

The **Custom** setting allows you to click and drag on any of the 2 midrange nodes on the graph in order to adjust the temperature parameters of the **CPU Fan** or **GPU Fan** (click on the CPU Fan or GPU Fan icon for either on to select it, then click and drag either of the midrange nodes), then click **Save** to retain the setting changes.



Figure B - 2 - CPU/GPU Fan Custom Settings

Power Modes

Power Modes allows you to adjust the power mode by clicking the appropriate icon.



Figure B - 3 - Power Modes

- **Power Saving** mode focuses on saving battery life (the CPU Turbo Boost and dGPU Turbo will be off).
- **Quiet** mode focuses on reducing fan noise and will decrease both CPU power and GPU power.
- **Entertainment** balances CPU and GPU power and is ideal for watching videos etc.
- **Performance** mode is ideal for gaming with higher CPU and GPU performance.

LED Keyboard

The LED Keyboard menu will allow to configure the backlight LED. There are 2 types of menu available depending on which type of keyboard your system supports (either the standard **illuminated colored LED keyboard** or **illuminated colored “Per Key” LED keyboard**).

- You can change the colors for the whole keyboard **illuminated colored LED keyboard**.
- You can change the colors for individual keys on the **illuminated colored “Per Key” LED Keyboard**.

The LED **Keyboard** application can be accessed by pressing the **Fn** plus  key (or by clicking **LED Keyboard** in the Control Center), or from the **Windows Start** menu  .



Override Boot Effect

On boot the colored keyboard will momentarily flash. You can click in the **Override Boot Effect** check box to disable the keyboard flashing effect as the system boots.

Control Center

LED Keyboard - Illuminated Colored LED Keyboards

Use the **Keyboard Sleep Timer** to select the amount of time the system for which the system is idle before the keyboard LED enters sleep mode (i.e. the LED keyboard illumination will turn off to save power). You can also adjust the **Brightness**.



Figure B - 4 - LED Mode for Illuminated Colored LED Keyboards Only

Color Swatch

The color swatch in the middle of the screen allows you to select a range of colors for your keyboard backlight by clicking on the color required. Click to select any colors from the swatch to apply to the keyboard.



Figure B - 5 - Keyboard Color Swatch

Keyboard Sleep Timer

Enable and then select the amount of time the system for which the system is idle before the keyboard LED enters sleep mode (i.e. the LED keyboard illumination will turn off to save power).

Brightness

Click on any of the numbers (1 - 4) on the **Brightness** bar to set the brightness level of the LED Device. You can also turn the keyboard backlight LED Device off by clicking the **OFF** button, or by using the **Fn** plus  key.

Control Center

LED Device Menu - Illuminated Colored “Per Key” LED Keyboards

Click **Keyboard**, on the left under **LED Mode**, to set individual color settings for any keyboard keys you may wish to highlight.

Simply click to highlight any keys to which you wish to apply the color, and then click a color from the swatch to apply the color. To highlight further keys first click to deselect any previously selected keys, then repeat the above procedure. To clear settings click **Restore**.



Figure B - 6 - LED Mode - Illuminated Colored “Per Key” LED Keyboards

Keyboard Effects (for Illuminated Colored “Per Key” LED Keyboards)

Click on **Keyboard Effect** (under **LED Mode**) and then click any of the Effect buttons (Wave, Breath, Scan, Blink, Random, Ripple or Snake) to view the effects on the keyboard. You can also adjust the **LED Speed** for the effects from the buttons on the right. Some effect colors can set to **Random** or **Custom**



Figure B - 7 - Keyboard Effects - Illuminated Colored “Per Key” LED Keyboards

Flexikey® Application

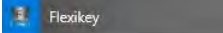
Click **Flexikey** in the **Control Center** or **Start** menu  to launch the application.

Profiles

The controls at the top right side of the application relate to Profiles. You can **Add/Delete** Profiles (**you can maintain 12 active Profiles**), **Export** and **Import** profiles by clicking on the appropriate icon. If you double-click on a Profile you can change the **Profile Name**, and import an **Image** file (images created using PNG files).



Windows Key
Fn & P Keys

Note that you can assign actions to any keyboard key except the Windows key  Fn and P key.

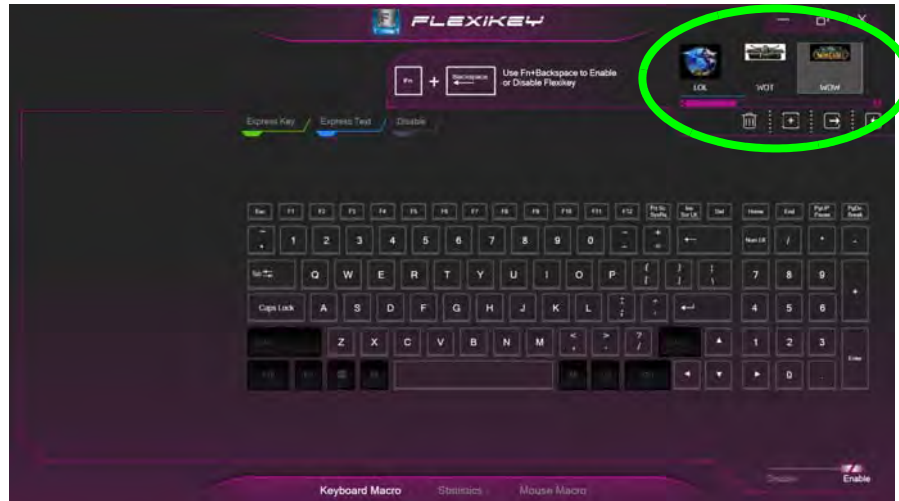



Figure B - 8 - Flexikey® - Profiles (Keyboard Macro)

- **EXPRESS KEY** - This feature allows you to configure a single key to send multiple key combinations or to create more useful shortcut keys. This is useful in gaming or when using applications which have a complex set of keyboard shortcuts.
- **EXPRESS TEXT** - With this you can assign single keys to send commonly used strings of text.
- **DISABLE** - Use this function to disable any keyboard keys.
- **STATISTICS** - Use this to quickly record keys in use in any application, and to disable unused keys.

Keyboard Macro and Mouse Macro Settings

Click **Enable**  (at the bottom right of the screen) to create settings for the keyboard and/or mouse by clicking the tab at the bottom of the screen. Clicking on **Keyboard Macro** or **Mouse Macro** allows you to access the settings page for the either the keyboard or mouse.

Enabling or Disabling Flexikey®

You can enable or disable Flexikey® (and therefore any hotkeys or mouse profile functions currently in use) by using the **Fn + Backspace** key combination. Pressing this key combination will toggle you between the currently selected keyboard or mouse profile to the standard keyboard and/or mouse settings, and back again. An on screen icon will also pop-up to display the status of the application as it is toggled on/off.



Figure B - 9 - FlexiKey On Screen Icons

Control Center

Keyboard Macro

The keyboard macro settings allow you to configure actions for any single key (or a combination of keys). Click the key and then select the action type (**Express Key**, **Express Text** or **Disable**) from the menu at the top of the page.



Windows Key
Fn & P Keys

Note that you can assign actions to any keyboard key except the Windows key and P key.



Figure B - 10 - Keyboard Macro

B

Mouse Macro

When an external mouse is attached, the mouse macro settings allow you to configure actions for the left **1**, right **2** and middle **3** buttons of the attached mouse, and also for any backward **4** and forward **5** buttons if applicable (on a gaming type mouse). Click the button number and then select the action type (**Express Key**, **Express Text** or **Disable**) from the menu.

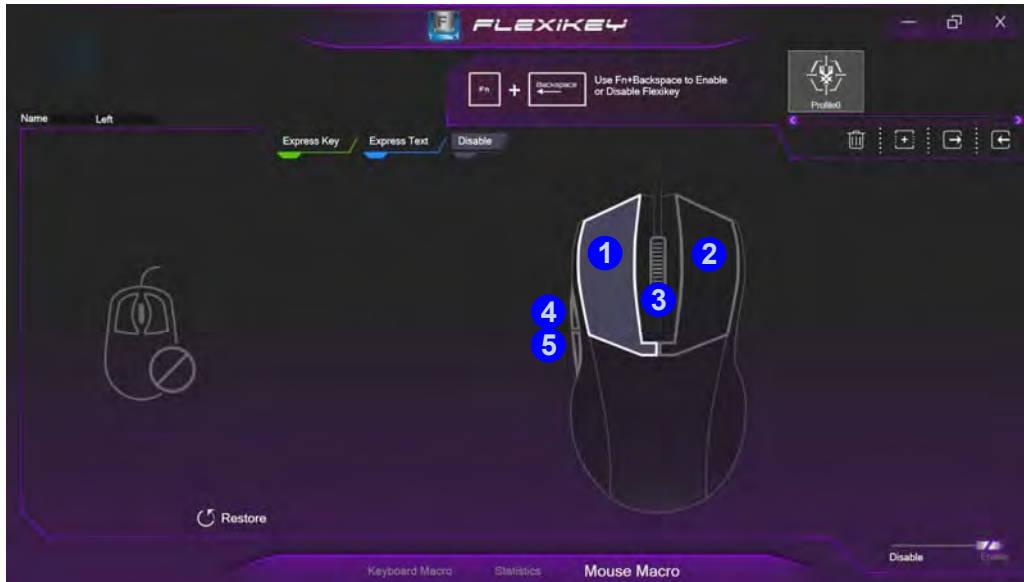

Figure B - 11 - Mouse Macro Configuration



Keyboard Macro - Express Key

To configure a single key to send multiple key combinations, or to create more useful shortcut keys, use **Express Key**.

1. **Enable** and select the keyboard, click on the chosen key to select it, and then click to select **Express Key**.



Figure B - 12 - Keyboard Macro - Record Express Key

2. In the following example we want to change an existing game key configuration which uses the **left shift** key for sprinting, and the **W** key for moving forwards, to use the **1** key to combine this movement to sprint forward.
3. Click the **Record** button  and then **press** the key or keys (in this case we will **press** Left Shift and W) required (make sure you **press the key(s) required** and do not click on them).
4. Click the **Record** button  again to complete the process and stop recording.
5. If you want to remove any individual key click to select it, and then click **Restore**.
6. Any assigned **Express Keys** will be highlighted in **green**.

Control Center

Enabling Delay Time

If you want to create a delay between key presses within the key combination, then you can use **Enable Delay Time** function to do so.



1. **Enable** and select the keyboard under your chosen profile, click on the chosen key to select it, and then click to select **Express Key**.
2. Click the **Record** button  and then **press** the key or keys required in the sequence and time delay between key presses required (make sure you **press the key(s) required** and do not click on them).
3. Click the **Record** button  again to complete the process and stop recording.
4. Click to select a key in the sequence and click **Enable Delay Time** , then click a key to view the time delay.



Figure B - 13 - Enable Delay Time

- You can edit the delay between key presses by clicking in the **Delay Time (MS)** field and typing a new number for the delay between the key presses.



Figure B - 14 - Time Record Between Key Presses

- If you want to remove any individual key click to select it, and then click the delete  symbol.
- If you want to clear all the settings click **Restore** to return to the default key setting.

Keyboard Macro - Express Text

A single key can be set to send a string of text within any application using **Express Text**.

1. **Enable** and select the keyboard, click to select a key, and then click to select **Express Text**.
2. Click the **Record** button in **Start Key** and press the keys to use (the **Start** key is the key used to in your target program to open a text message).
3. Click in the **Text Context** field and type in your message and click **Save**.



Figure B - 15 - Keyboard Macro - Express Text

4. Click the **Record** button in **Send** and press the keys to use if required (the **Send** key is the key used to in your target program to send a text message e.g. the Enter key would be the most commonly used).
5. The key will now be configured to send the text message in the target program under your chosen Profile, and the key will appear in **blue**.
6. If you want to remove any **Express Text** key, select it and click on **Restore**.



Copy & Paste Text

Note that some applications and games do not support copy and pasted text. Where this is the case, any text you may have copy and pasted in to the “Type to Text” field may not be displayed within the application. In this case you will need to type the text into the field instead.



Keyboard Macro - Disable

You can use the program to disable any keys not required.

1. **Enable** and select the keyboard, click to select a key to disable, and then click to select **Disable**.
2. The key will now be disabled.
3. If you want to enable the key again, select it and click on **Restore**.
4. The key will be disabled, and the key will appear in **Gray**.

Mouse Macro - Express Key

To assign a mouse button click to send multiple key combinations (an external mouse must be attached), or to create more useful shortcut keys, use **Express Key**.

1. **Enable** and select the mouse, click on a mouse button to select it, and then click to select **Express Key**.
2. In the following example we will configure the central mouse wheel to combine the actions of **left shift** key for sprinting, and the **W** key for moving forwards in a game program.
3. Click on the central mouse wheel for the shortcut action.
4. Click the **Record** button  and then **press** the key or keys (in this case we will **press** Left Shift and W) required (make sure you **press the key(s) required** and do not click on them).
5. Click the **Record** button  again to complete the process and stop recording.
6. If you want to remove any mouse setting click to select it, and then click **Restore**.
7. The mouse button for any assigned Express Keys will appear in **green**.

Enabling Time Record for Mouse Settings

If you want to create a delay between key presses within the mouse click combination, then you can use **Time Record** function to do so in the same manner as that used for keyboard settings (see *“Enabling Delay Time” on page B - 16*).

Mouse Macro - Express Text

A mouse button click can be set to send a string of text within any application using **Express Text**.

1. **Enable** and select the mouse, click on a mouse button to select it, and then click to select **Express Text**.
2. Click the **Record** button in **Start** key and press the keys to use (the **Start** key is the key used to in your target program to open a text message). Click the **Record** button again to stop the process.
3. Click in the **Text Context** field and type in your message and click **Save**.
4. Click the **Record** button in **Send** and press the keys to use (the **Send** key is the key used to in your target program to send a text message e.g. the Enter key would be the most commonly used). Click the **Record** button again to stop the process.
5. The key will now be configured to send the text message in the target program under your chosen Profile, and the key will appear in **blue**.
6. If you want to remove any **Express Text** key, select it and click on **Restore**.



Copy & Paste Text

Note that some applications and games do not support copy and pasted text. Where this is the case, any text you may have copy and pasted in to the "Type to Text" field may not be displayed within the application. In this case you will need to type the text into the field instead.

Mouse Macro - Disable

You can use the program to disable any mouse button clicks if not required.

1. **Enable** and select the mouse, click on a mouse button to select it, and then click to select **Disable**.
2. The button click will now be disabled.
3. If you want to enable the button again, select it and click on **Restore**.
4. The button click will be disabled under your chosen Profile, and the key will appear in **Gray**.

Statistics

The **Statistics** tab allows you to record keys used in any application, and to **disable** any infrequently, or unused, keys to save any accidental incorrect key presses.

1. Click the **Statistics** Tab, and press the **Record** button to start recording the frequency of key presses for keys used.
2. You can then go to the application for which you wish to use the profile, and use the application as per normal so that a standard set of keys used may be recorded.
3. Return to the Flexikey® application and press **Record** button again to stop recording.
4. At the end of the recording process colors will represent the frequency of key presses, with the darker keys as the most frequent through to lighter the less frequent (the color dial on the left of the screen displays the color code against the number of key presses).
5. You can move the mouse over any key to see the number of times it has been pressed.
6. If you want to disable a key click **Quick Disable** and click the keys you wish to disable (the key will become grayed out) and then click **Save** to retain the settings.



Figure B - 16 - Statistics

Appendix C: Video Driver Controls

Overview

The video features for this computer can be configured using the **Windows Display Settings**, **Intel Graphics Command Center** or **NVIDIA** control panel.



Configuring External Displays

You can use the **System** (in **Settings** - page **C - 9**) control panel or the  + **P** (or **Fn + F7** - page **C - 8**) key combination, to configure an external display.

External displays can also be configured the **Intel(R) Graphics Command Center** (see page **C - 49**).

You can also use the **NVIDIA** (see page **C - 26**) control panel to configure the external displays.



Video Card Options

Note that card types, specifications and drivers are subject to continual updates and changes. Check with your distributor/supplier for the latest details on video cards supported.

Microsoft Hybrid Graphics

Most notebook computers come with either a **discrete** or **integrated** graphics solution.

Discrete graphics solutions feature a dedicated Graphics Processing Unit (GPU) which are capable of playing games, watching HD video or running GPU-based applications. However computers with discrete graphics solutions tend to be heavy in power consumption, and slightly larger in size in order to incorporate the dedicated discrete GPU.

Integrated graphics solutions usually feature memory sharing technology to help save power consumption and allow for longer battery life. However computers with integrated graphics solutions will not usually run games, HD video or GPU-based applications without severe limitations.

Microsoft Hybrid Graphics is a seamless switchable graphics technology designed to get best performance from the graphics system while allowing longer battery life, without having to manually change settings. Thus when an application is run that requires extra performance or quality, then the operating system will run the discrete GPU (dGPU); when the system does not require such enhanced performance it will let the integrated (iGPU) handle it.

How Switchable Technology works

When the system is powered up and is displaying just the desktop, the dGPU will be powered off. In this case the system is running in the same way as a system without a discrete graphics solution. However when an application that requires use of the dGPU is run (e.g, a game or HD Video), the dGPU is powered on and takes over the processing duties. If the program is closed, then the dGPU will be powered back down again until required.





Video Card Options

Note that card types, specifications and drivers are subject to continual updates and changes. Check with your distributor/supplier for the latest details on video cards supported.

Video Driver Installation

Make sure you install the drivers in the order indicated in *Table 4 - 1, on page 4 - 5*. Insert the *Device Drivers & Utilities + User's Manual* disc into an attached DVD drive and click **Install Drivers** (button).

Intel Video (VGA)

1. Click **3.Install Intel VGA Driver > Yes**.
2. Click **Next > Yes > Next > Next**.
3. Click **Finish** to restart the computer.
4. **Intel Graphics Command Center** will download but you will need to have a working internet connection.
5. Click the **Start** menu in Windows to access the **Microsoft Store** app tile under **Explore**.
6. Click the **Sign in** icon  and select **Downloads and updates**.
7. Click **Check for Updates**, and a list of apps being downloaded will pop-up.
8. To prioritize the Realtek audio driver you can click **Pause all** to pause the download queue.
9. Click on **Intel Graphics Command Center** and click on the resume icon  to download the driver.
10. When finished the **Intel Graphics Command Center** will appear in the **Windows Start** menu.

NVIDIA Video (VGA)

1. Click **4.Install NVIDIA VGA Driver > Yes**.
2. Click **AGREE AND CONTINUE** (button) to accept the terms of the license agreement.
3. Click **NEXT**.
4. Click **Close** to complete the installation.
5. Go to the Microsoft Store to download the NVIDIA Control Panel.
6. After all the drivers have been installed (an internet connection is required) run the **NVIDIA GeForce Experience** by clicking the desktop icon  (or App).

Note: After installing the video driver go to the **Display** control panel to adjust the video settings to the highest resolution.



NVIDIA GeForce Experience Version

Note that the NVIDIA GeForce Experience application is subject to constant, change, update and revision, so make sure you connect and update regularly in order to get the latest settings and information.

NVIDIA GeForce Experience

If you have a working internet connection (and you will need remain connected to the internet to run **NVIDIA GeForce Experience**) you can click the **NVIDIA GeForce Experience** desktop icon  (or App) to run the application. This will optimize your gaming settings for your NVIDIA GPU by downloading the latest settings from the NVIDIA cloud data center.

You may need to create an NVIDIA account to log-in to the system (alternatively you may be able to use your Facebook or Google account to log-in).

After logging in to the system you can click through any on-screen instructions to update your settings and check for installed games etc.

By running the **NVIDIA GeForce Experience** you will be able to download the latest drivers to insure compatibility with games, power saving features and various other enhancements for your NVIDIA GPU (these features are subject to change and update so check with the NVIDIA website for the latest information).

Note that to enable **BatteryBoost** you must be connected to the internet (see over).

NVIDIA GeForce Experience - BatteryBoost

BatteryBoost allows you to optimize your system's battery life when gaming. You can adjust the **BatteryBoost** slider in **Preferences > BatteryBoost** (make sure you have restarted the computer after the first run of **NVIDIA GeForce Experience**).

Running BatteryBoost

1. On first run of **NVIDIA GeForce Experience** you should be connected to the internet (BatteryBoost will not appear at this stage).
2. After the first run you should restart the computer manually, but you must still be connected to the internet (the LAN cable should be plugged-in, or your WiFi connection should be set to **Connect Automatically**) as the computer restarts.
3. BatteryBoost will be present when **NVIDIA GeForce Experience** is run again.

Click to put a tick in the box alongside **BatteryBoost** to enable the feature, then adjust the slider towards **Longer battery life** or **Higher performance** as preferred.

Configure Other Displays Using Project

You can configure attached displays from **Project**.

1. Attach your external display(s) to the appropriate port, and turn it(them) on.
2. Press the **Windows + P** key combination.
3. Click on any one of the options from the menu to select **PC screen only**, **Duplicate**, **Extend** or **Second screen only**.
4. You can also click **Connect to a wireless display** at the bottom of the **Project** screen and follow the steps to connect to any wireless enabled display.

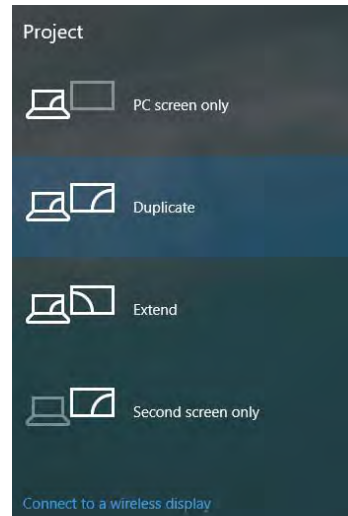

Figure C - 1
Project

Configuring an External Display In Windows

The **System > Display** Control Panel in **Settings** may also be used to configure displays.

1. Attach your external display to the appropriate port, and turn it on.
2. Click the Start Menu and click **Settings > System** (or right-click the desktop and select **Display Settings**).
3. Click the **Multiple Displays** menu and select **Duplicate these displays**, **Extend these displays** or **Show only on 1/2**.
4. Click **Keep changes** to save any changes made.

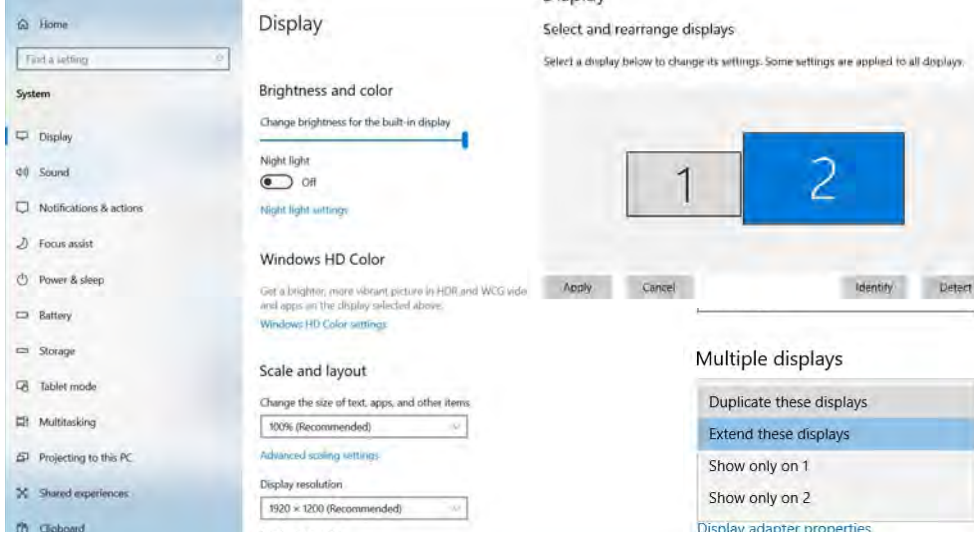

Figure C - 2
System > Display
(Multiple Displays)

Video Driver Controls



4 Connected Displays

Note that when 4 displays are connected, only 2 displays may be configured in Duplicate mode.

5. You can configure up to 4 displays from the **System > Display** menu.

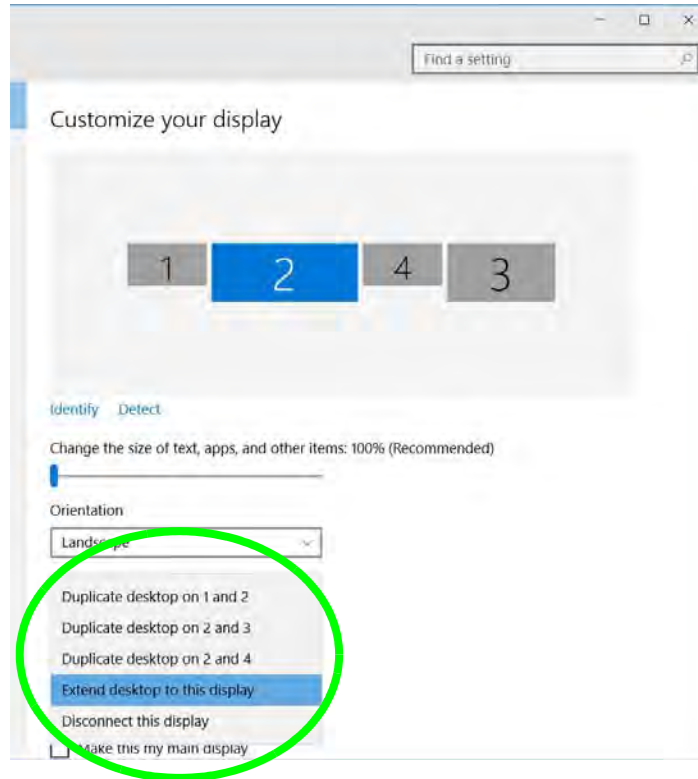

Figure C - 3

System > Display (4 Connected Displays)

HDMI Audio Configuration

HDMI (High-Definition Multimedia Interface) carries both **audio** and video signals. In some cases it will be necessary to go to the **Sound** control panel and manually configure the HDMI audio output as per the instructions below.

1. Go to the **Sound** control panel.
2. Click **Playback** (tab)
3. The playback device will be selected.
4. You may need to select the audio device and click **Set Default** (button).
5. Double-click the device to access the control panel tabs.

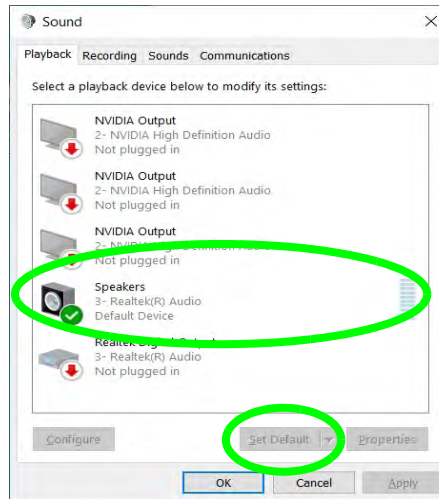

Volume Adjustment

The sound volume level can be clicking using the volume control icon  in the **notification area of the taskbar**.



Figure C - 4

**Sound - HDMI
Device (Set Default)**

Video Driver Controls

- Adjust the HDMI settings from the control panel tabs.
- Click **OK** to close the **Sound** control panel.

Figure C - 5
HDMI Device Properties

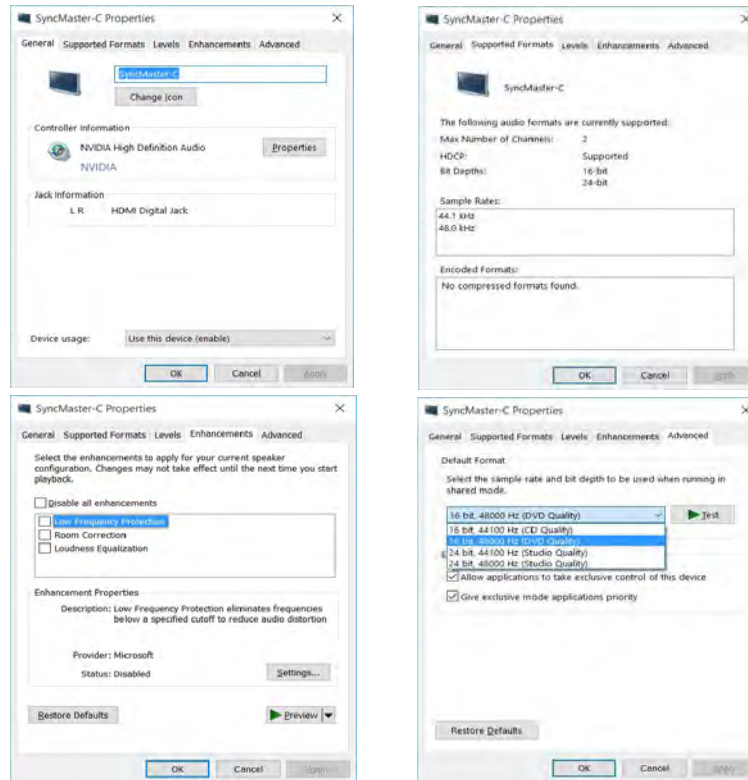

HDMI Notes

- Connect a device with HDMI support to the HDMI-Out port **BEFORE** attempting to play audio/video sources through the device.
- To play audio sources through your external display's (TV or LCD) speakers you will need to go to the audio configuration control panel on the display and configure the audio input accordingly (see your display device manual).

HDMI Video Configuration

1. Connect an HDMI cable from the HDMI-Out port to your external display.
2. Configure your external display as per the instructions in this chapter.
3. Set up your external display (TV or LCD) for HDMI input (see your display device manual).
4. You can now play video/audio sources through your external display.



Other Applications

If you are using a third party application to play DVDs etc. from any attached DVD device, you will need to consult the application's documentation to see the appropriate audio configuration (the application must support digital to analog translation).



Compatible Adapters

For a list of compatible adapters check the video adapter/display device documentation, or with your distributor/supplier.

Wireless Display

Wireless Display uses your Wireless LAN module/WLAN Bluetooth Combo module (**you need to make sure that your video adapter/display device is compatible with your particular WLAN/Combo module**) in conjunction with a **compatible video adapter/display device** (purchased separately) to allow you to display the contents of the notebook display on another display (e.g. HDTV), without the need to have cables stretching across a room.

You can use the wireless display to play games, browse the internet, display videos or photo slide shows on your TV/external display without using HDMI or A/V cables.

Before configuring **Wireless Display** you will need to set up your **compatible adapter** with your display/speakers. Connect the adapter using an HDMI or A/V cable and turn on the display (or in the case of speakers connect them to the wireless speaker adapter with the cables provided with the adapter), and then set the display to the appropriate input channel (see the documentation supplied with your **compatible adapter/display** for full details).

*Note that no driver or application is required for wireless display in **Windows 10**.*

Wireless Display Configuration

1. Note that no driver or application is required for wireless display in **Windows 10**.
2. Press the **Windows + P** key combination.
3. Click **Connect to a wireless display** at the bottom of the **Project** screen and follow the steps to connect to any wireless enabled display.



Figure C - 6
Add a Wireless Display

4. The system will then search for compatible display devices (**this may take up to 60 seconds** so allow time for this to complete).
5. Double-click any detected display device in the list.

Video Driver Controls

6. Double-click any detected display device in the list.
7. You may then need to input a pin number for the device to which you are connecting and click **Next**.
8. The display will then connect (for specific settings for your display see the documentation supplied with your compatible adapter/display for full details).
9. Go to the **Project** menu and click **Disconnect** to temporarily disconnect from the wireless display.
10. To permanently disconnect from the display (you will need to go back through the connection process again) you can select it in **Devices** and click **Remove Device** > **Yes**.

NVIDIA Control Panel

More advanced video configuration options are provided in the **NVIDIA Control Panel** tab.

1. Access the **NVIDIA Control Panel** from the **Start** menu in **Windows** (or right-click the desktop and select **NVIDIA Control Panel**).
2. To configure displays in **Discrete** mode you can use the **NVIDIA Control Panel**.

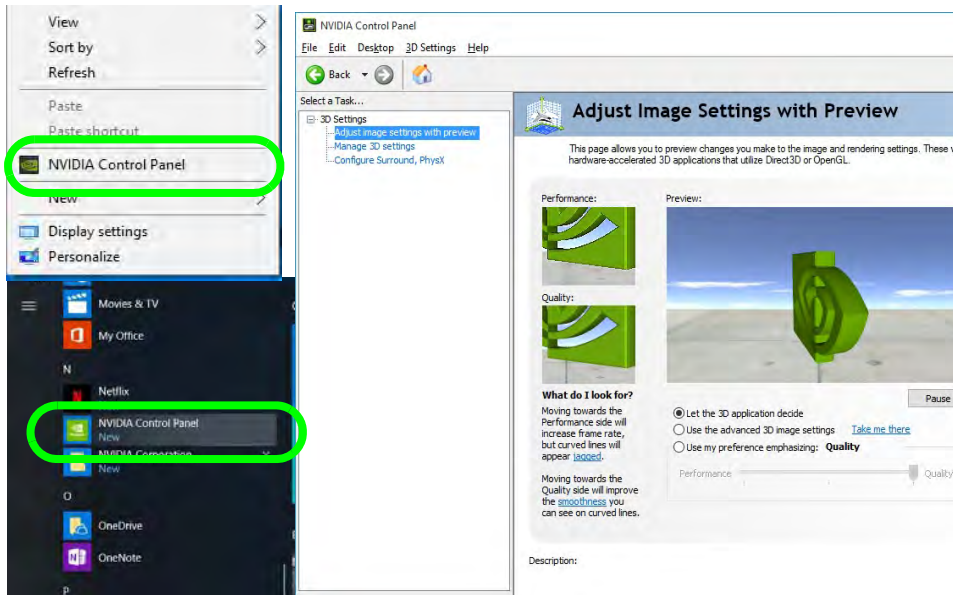

Figure C - 7
NVIDIA Control
Panel

Video Driver Controls



Navigating the Control Panel

Navigate through the control panels in much the same way as you would a web page. Click on the sub-heading tasks in the left menu (and on the highlighted links) for information. Use the buttons on the top left to go back, forward etc.

The **NVIDIA Control Panel** provides additional video configuration controls and tools which allow quick access to features such as image settings, 3D Settings and video configuration. **Additional menus will appear when external displays are attached to the *HDMI Port / Mini DisplayPort 1.4 / Thunderbolt 3 Port (set for display)*.**

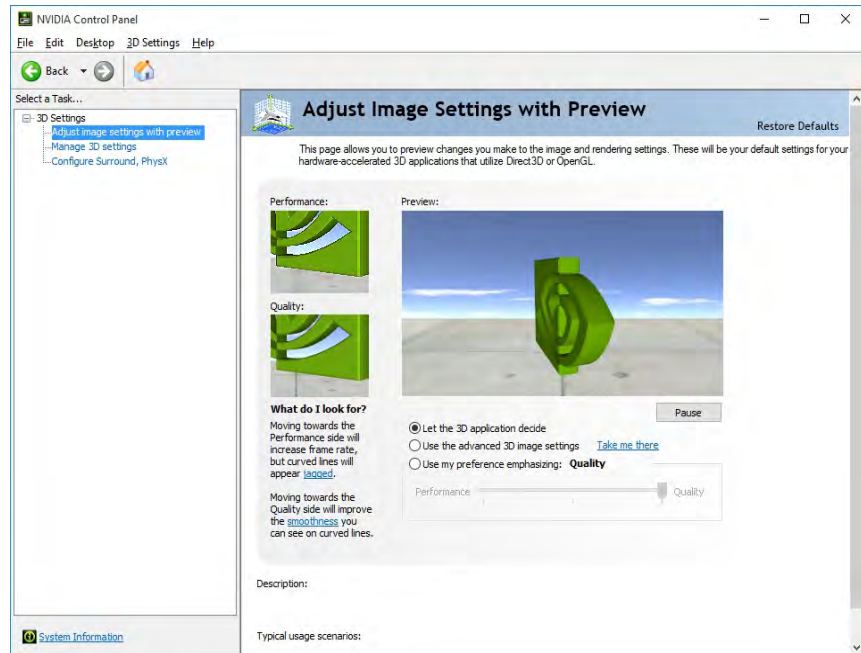

Figure C - 8

NVIDIA Control Panel (Basic)

Further menu items will appear in the NVIDIA Control Panel, in **Discrete** mode, with external displays attached to any of the external display ports.

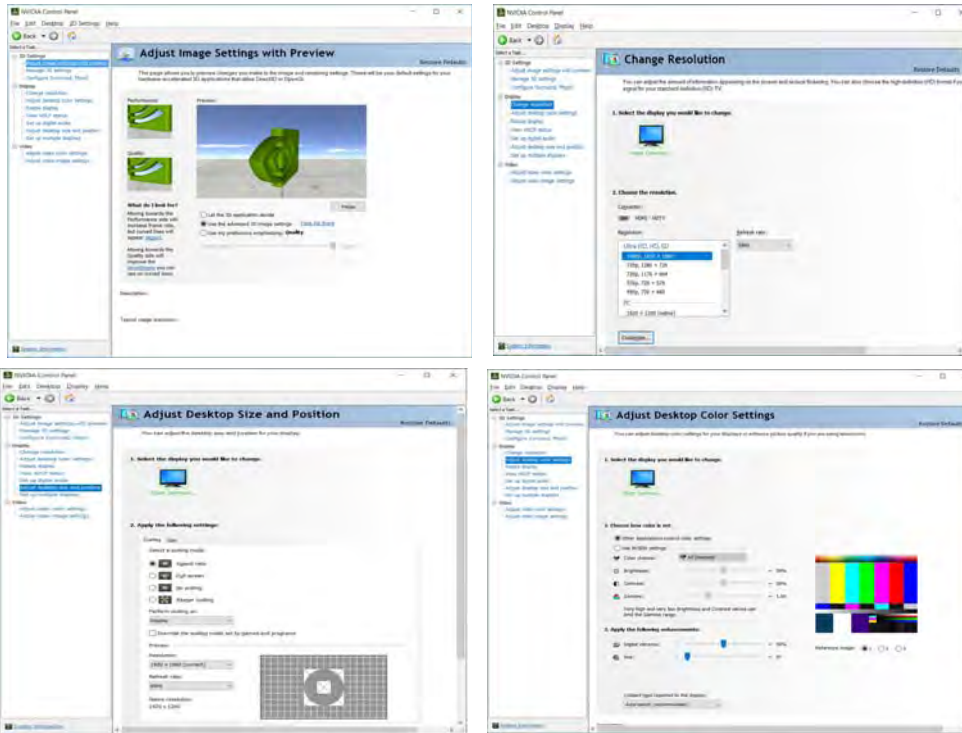

Figure C - 9
NVIDIA Control
Panel

*With External Display
Attached to HDMI Port /
Mini DisplayPort 1.4 /
Thunderbolt 3 Port (set
for display)*



Video Driver Controls

The **Help** menus provide index and search features, and direct links to the NVIDIA website etc.

Figure C - 10
Help Menu

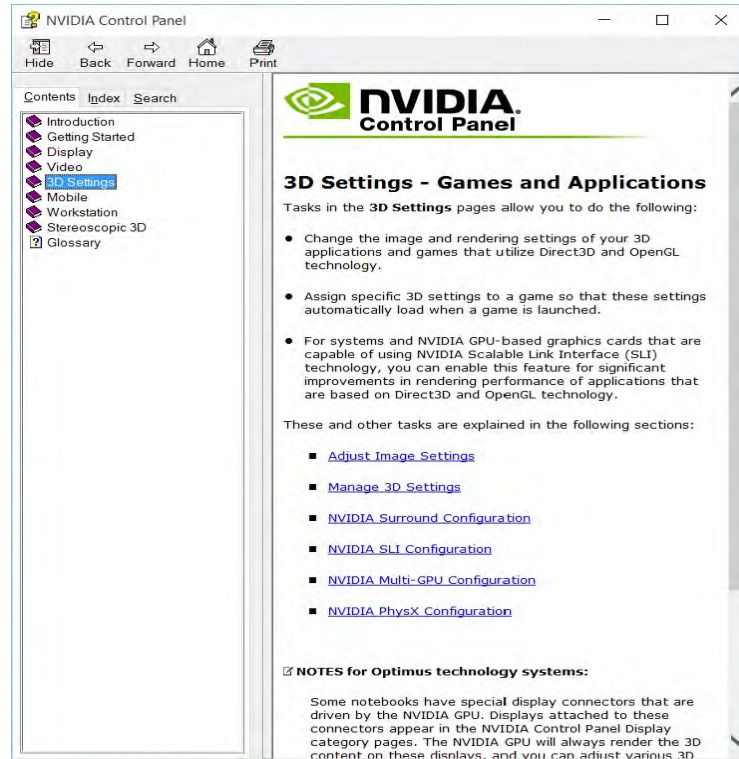

Customization Options

One of the most important aspects of hybrid technology is that it will switch between the integrated GPU and discrete GPU seamlessly and automatically, and does not require any input from the user. However customization options are offered for users who prefer to set their own parameters for GPU usage.

Context Menu

One of the quickest ways to choose which GPU to use for a particular application is by using the “**Run with graphics processor**” in the context menu.

1. Go to the **NVIDIA Control Panel**.
2. Click **Desktop** from the top menu and select **Add “Run with graphics processor” to Context Menu** (it should have a check alongside it).

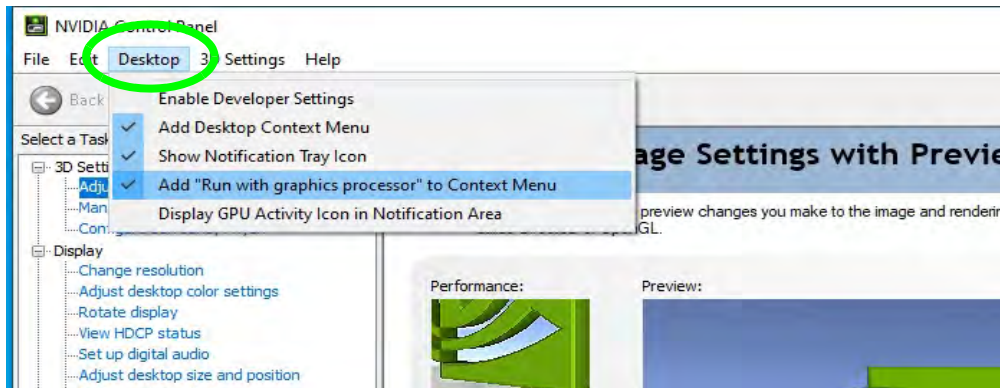

Display GPU Activity Icon

Click to enable **Display GPU Activity Icon in the Notification Area** to quickly access the GPU Activity monitor from the taskbar.

Figure C - 11
NVIDIA Control
Panel - View

Video Driver Controls



iGPU or dGPU

Note the NVIDIA control panel refers to **High-performance NVIDIA processor** (which is the discrete GPU) and **Integrated graphics** (which is the integrated GPU).

3. Close the **NVIDIA Control Panel**.
4. Find the executable file icon of the application you want to run.
5. Right-click the icon and select **Run with graphics processor** from the context menu.
6. Select either **High-performance NVIDIA processor (dGPU)** or **Integrated graphics (iGPU)** to run the program with the selected GPU.

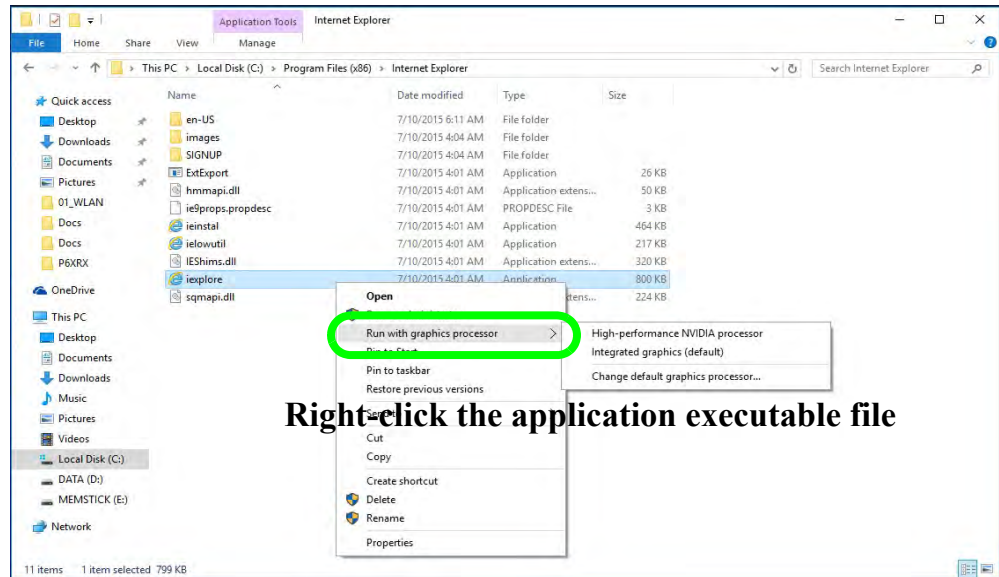

Figure C - 12

Context Menu with
Run with graphics
processor

C

Global Settings

Global settings allows you to set the preferred graphics processor for overall use. Ideally this would be the iGPU for battery life, but this can be set to the dGPU if preferred.

1. Go to the **NVIDIA Control Panel**.
2. Click **Manage 3D Settings (3D Settings)** and select **Global Settings** (tab).
3. Select either **Integrated graphics (iGPU)** or **High performance NVIDIA Processor (dGPU)** from the drop-down menu.
4. Click the **Setting** menu items to select any options required.
5. Click **Apply** to save the settings.

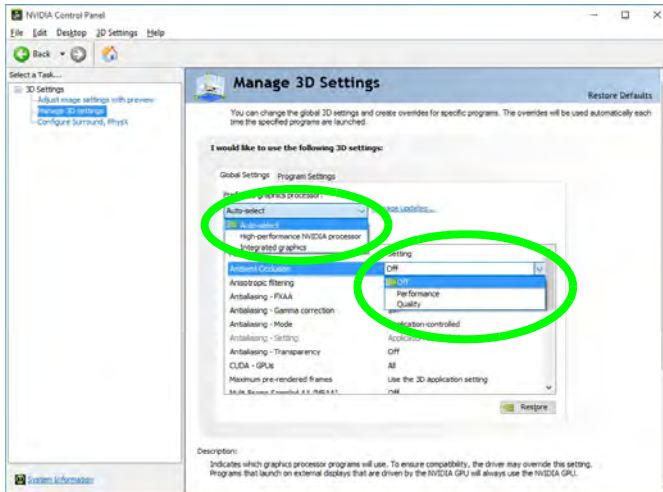



Customization Options

Although hybrid technology is completely seamless to the user, there are customization options within the control panel (see page [C - 20](#)).

Figure C - 13
Global Settings

Program Settings

Program settings allows you to make specific adjustments for installed applications.

1. Go to the **NVIDIA Control Panel**.
2. Click **Manage 3D Settings (3D Settings)** and select **Program Settings** (tab).
3. **Select a program to customize** from the drop-down menu, or click **Add** to add any program that does not appear in the menu.
4. **Select the preferred graphics processor for the program** from the drop-down menu.
5. Click the **Setting** menu items to select any options required.
6. Click **Apply** to save the settings.

Figure C - 14
Program Settings

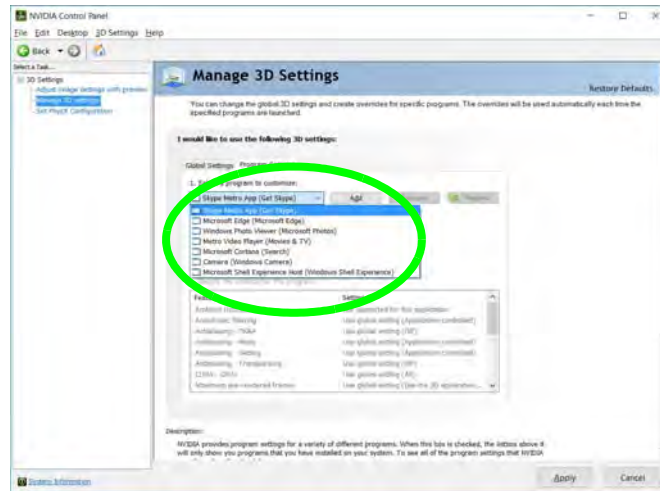

Change Resolution

You can **Change Resolution** for your attached displays from the NVIDIA control panel.

1. Attach your external display to the appropriate port, and turn it on.
2. Go to the **NVIDIA Control Panel**.
3. Double-click **Display** (if the sub-menus are not visible), and then click **Change resolution**.
4. Click to select the display, and then adjust the settings from “**2.Choose the resolution.**” and “**3.Apply the following settings.**”
5. Click **Apply** to save the settings.

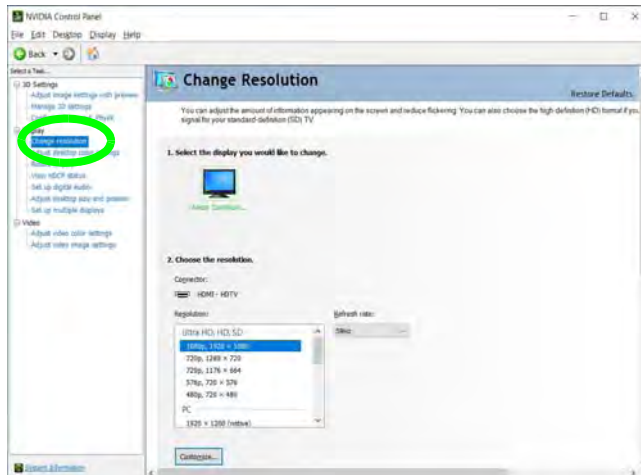

Figure C - 15
Change Resolution

Display Devices - NVIDIA CP

You can use the NVIDIA control panel to configure external displays.

Note that you can use an HDMI (High-Definition Multimedia Interface) cable connected to the HDMI-Out port, a DisplayPort compatible cable connected to the DisplayPort and/or a USB Type-C to HDMI or DisplayPort compatible cable connected to the Thunderbolt 3 port (set for display) to connect external displays. See your external display device's manual to see which formats it supports.



Configuring External Displays

You can use the **System** (in **Settings** - page **C - 9**) control panel or the  + **P** (or **Fn + F7** - page **C - 8**) key combination, to configure an external display.

External displays can also be configured the **Intel(R) Graphics Command Center** (see page **C - 49**).

You can also use the **NVIDIA** (see page **C - 26**) control panel to configure the external displays.

Display Mode	Description
Clone	Clone simply shows an exact copy of the Primary display desktop on the other displays. This mode will drive multiple displays with the same content.
Extend	Extend treats connected displays as separate devices, and they act as a virtual desktop resulting in a large workspace. When enabled, you can drag any icons or windows across to the other display desktop. It is therefore possible to have one program visible in one display, and a different program visible in the other display.

Table C - 1
Display Modes
NVIDIA



Display Not Shown

If the attached display does not appear in the “1.Select the displays you want to use.” window, click “My Display is not shown...” and then click the appropriate button to force detection of the missing display.

HDMI Audio Setup

See “HDMI Audio Configuration” on page C-11 for instructions on configuring audio for HDMI display devices.

Configuring an External Display (NVIDIA)

Clone the External Displays

1. Attach your external displays to the appropriate port, and turn them on.
2. Go to the **NVIDIA Control Panel**.
3. Double-click **Display** (if the sub-menus are not visible), and then click **Set up multiple displays**.
4. Any attached display will appear under “1.Select the displays you want to use.”

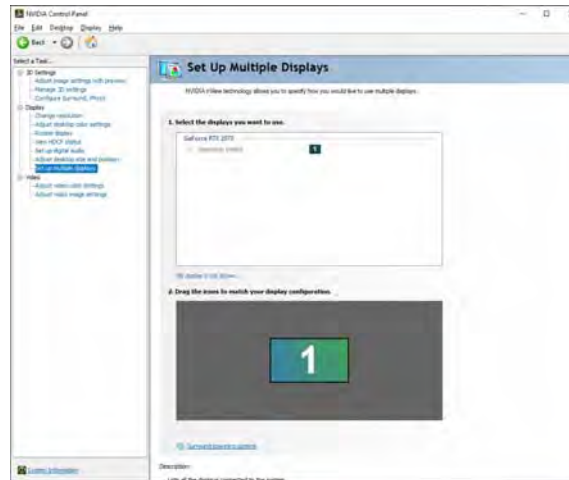

5. Click the check box alongside any display you wish to use.
6. Click **Apply > Yes** to save any changes made (the **Apply** button will appear in the bottom right of the control panel when changes have been made).

Figure C - 16

Set Up Multiple Displays

Extending the Display

1. Attach your external displays to the appropriate port, and turn them on.
2. Go to the **NVIDIA Control Panel**.
3. Double-click **Display** (if the sub-menus are not visible), and then click **Set up multiple displays**.
4. Click to select a primary display under “**1. Select the displays you want to use.**”
5. Right-click the icons under “**2. Drag the icons to match**” and select **Extend**.

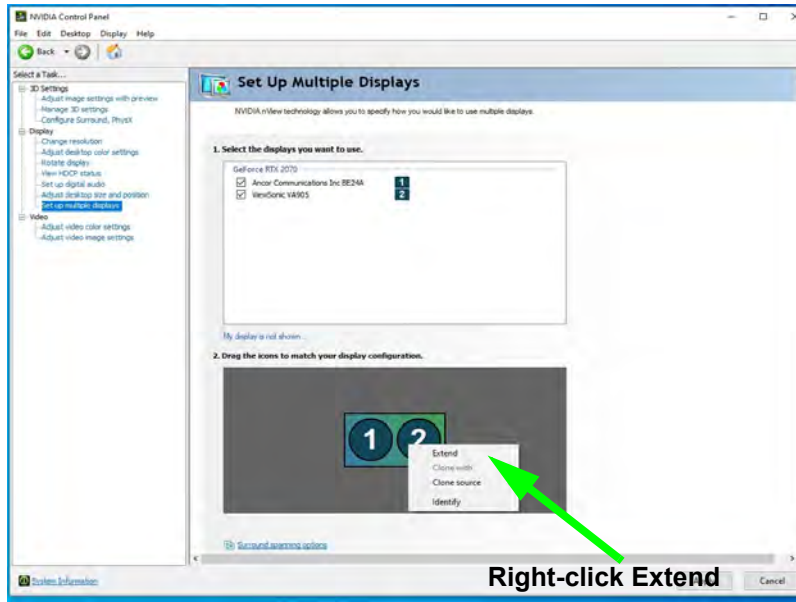

Changing the Primary Display on Extended Displays

If you want to switch the primary display if the displays are extended then right-click the secondary display icon and select “**Make Primary**”. Click **Apply > Yes** to save the change (see over).

Figure C - 17
Extend the Display

Video Driver Controls

6. The Primary display (the main window display) will be denoted by an **asterisk *** in the top right corner of the icon.
7. To change the Primary display **right-click the icon** and select **Make primary**.
8. Click **Apply > Yes** to save any changes.

Figure C - 18
Switch Primary Display

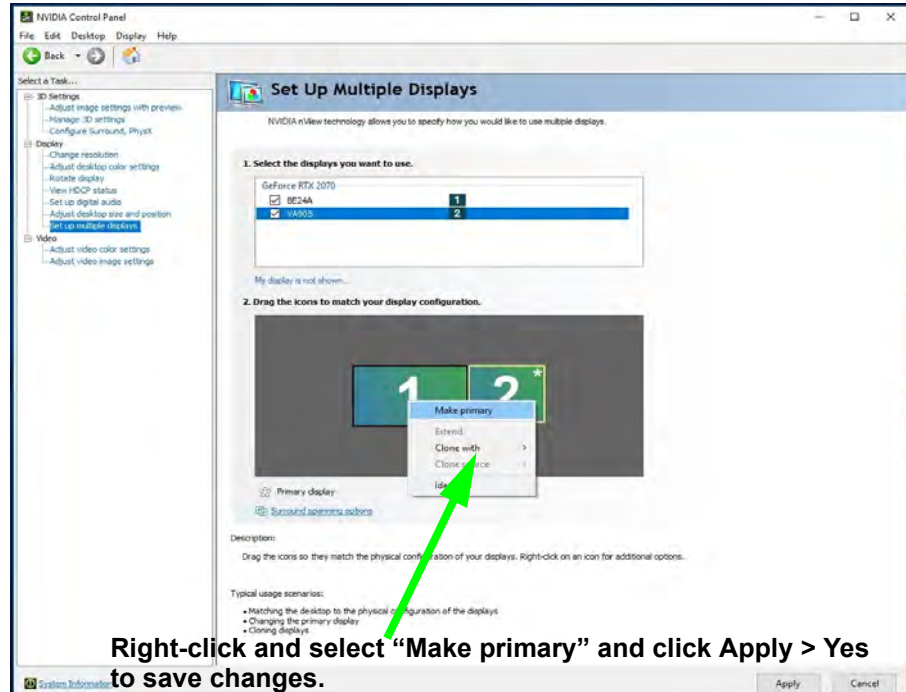

9. You can drag the icons to match the desktop layout you want to use (e.g. you may want to extend the display to the right or left of the primary display).
10. Click **Apply > Yes** to save any further changes.

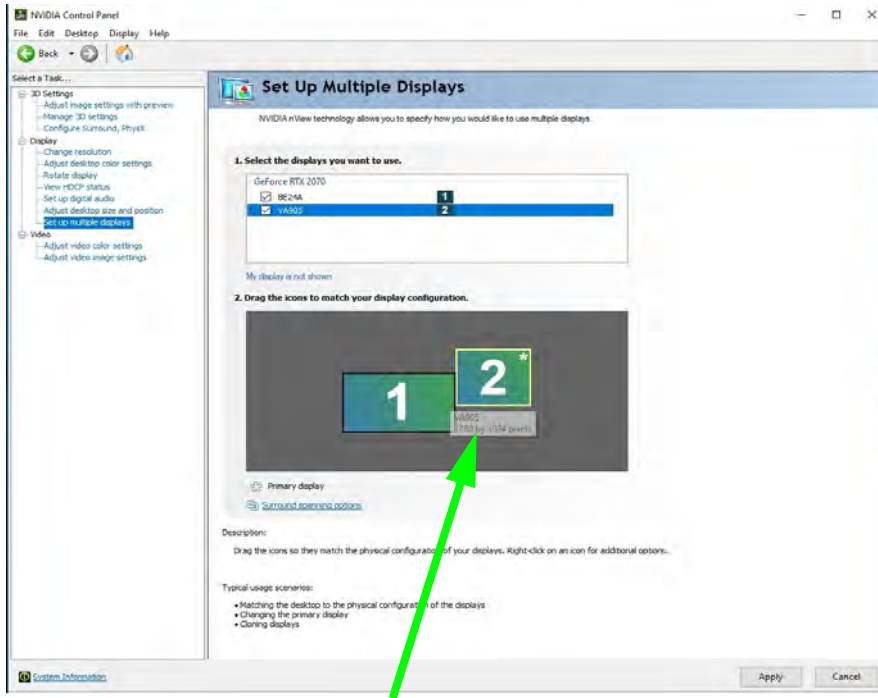

Figure C - 19
Drag Display
Icons

Drag the display icons to match the layout you want to use.

HDCP Status

If your external display is HDCP (High Bandwidth Digital Content protection) compatible then the NVIDIA control panel will display the HDCP system status.

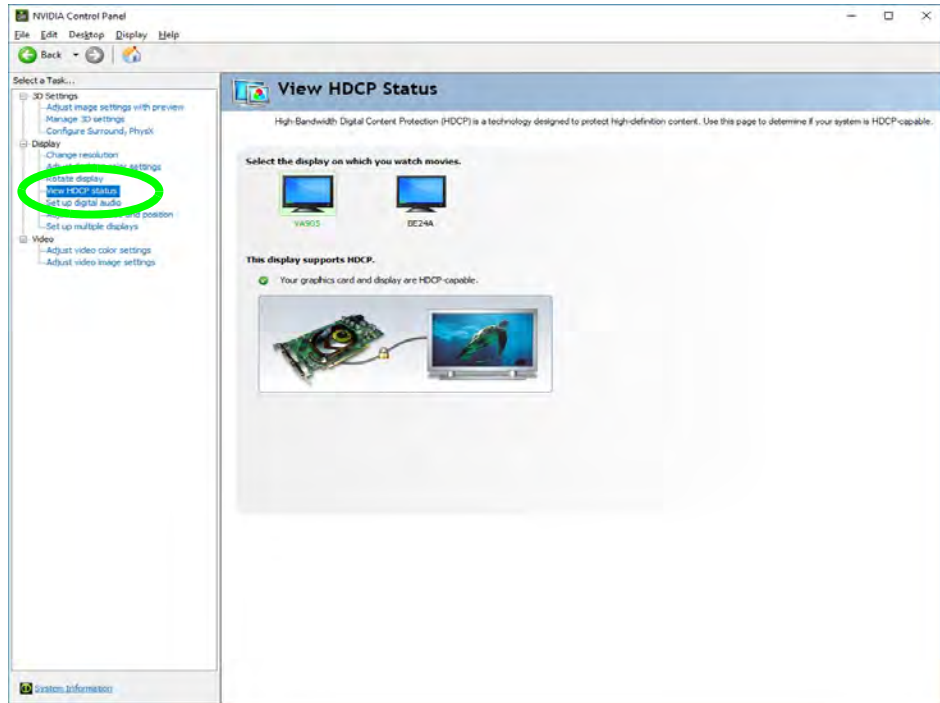

Figure C - 20
HDCP Status

Adjust Video Settings

You can adjust video color and image settings from the **Video** sub-menus.

1. Go to the **NVIDIA Control Panel**.
2. Click “+” next to **Video** if its sub-items are not shown and then click either **Adjust video color settings** or **Adjust video image settings**.
3. Make any adjustments required for any display and click **Apply** to save the settings.

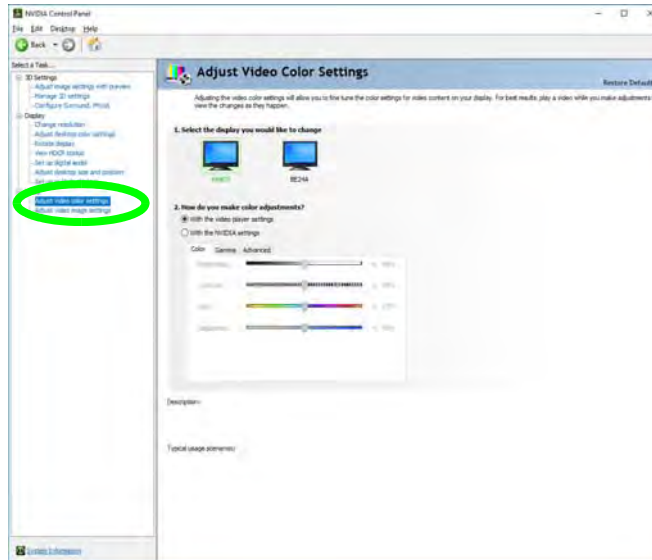

Figure C - 21
Adjust Video Color Settings

Configure Surround, PhysX®

NVIDIA® PhysX® is a physics engine that can use the GPU to accelerate game and 3D application performance. You can select the GeForce video card or CPU as a PhysX® processor, or configure the computer to auto-select a PhysX® processor (recommended default setting).

1. Go to the **NVIDIA Control Panel**.
2. Click **Configure Surround, PhysX**.
3. Click to select a processor from the menu (**PhysX Settings**); Auto-select (recommended) is the default setting.
4. Click **Apply** to save the settings.

Figure C - 22
Configure Surround, PhysX

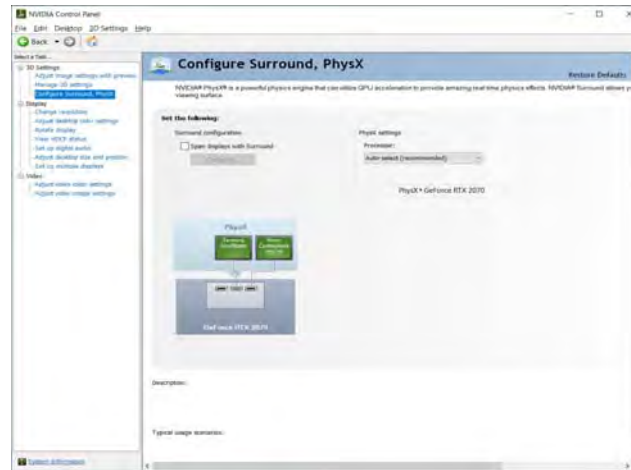

Set Digital Audio

As HDMI (High-Definition Multimedia Interface) carries both **audio** and video signals you can configure the audio output from the **NVIDIA control panel** and **Sound** control panel. The settings will depend upon the external HDMI display to which you have connected.

Connected displays will appear alongside the appropriate port. Click **“Open Windows Sound Settings”** (button) to access the **Sound** control panel.

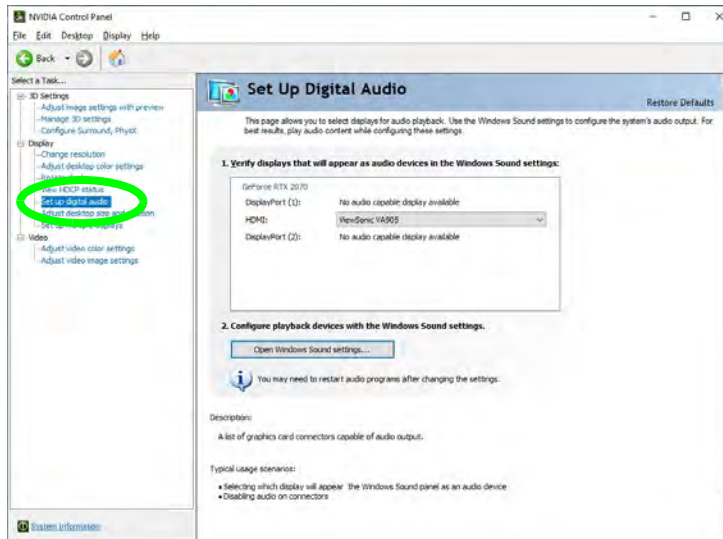

Figure C - 23
Set up Digital Audio

Intel® Graphics Command Center

Advanced video configuration options are provided by the **Intel Graphics Command Center**.

1. Access the **Intel Graphics Command Center** from the **Start** menu in **Windows**.

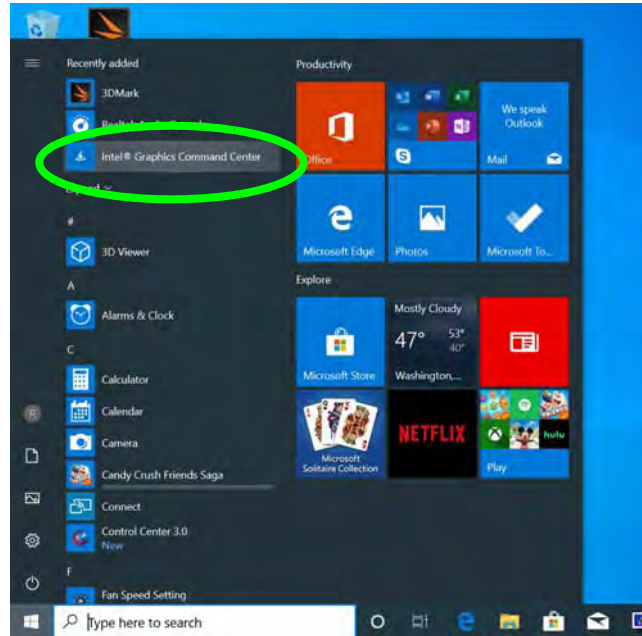

Figure C - 24
Intel® Graphics Command Center (Windows Start Menu)

OR

- You can **right-click** the **Intel Graphics Command Center** in the **Start** menu and pin the control panel to the taskbar.

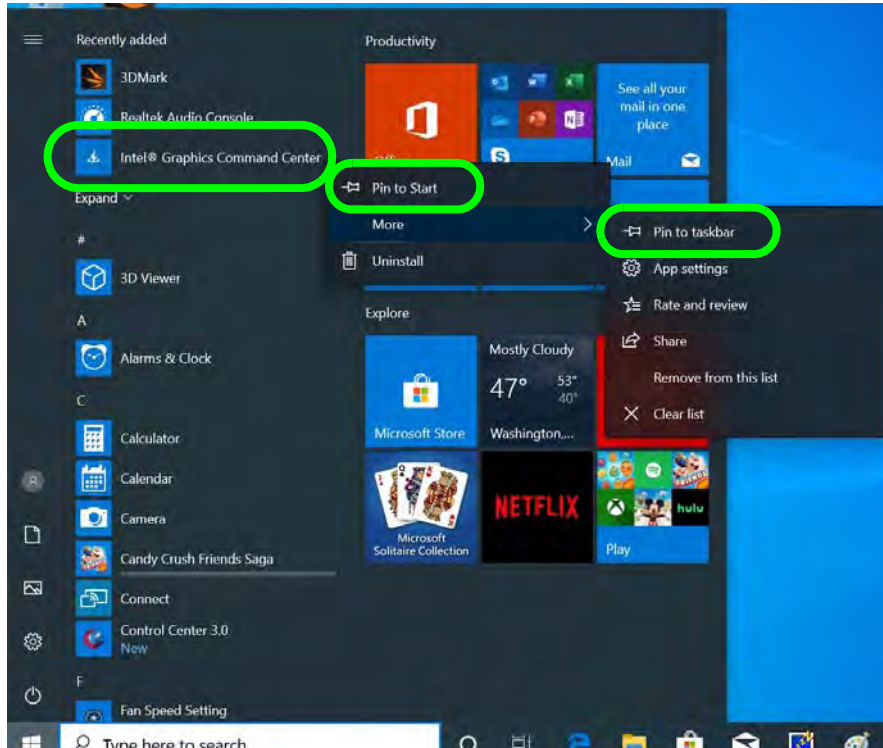

Figure C - 25
Intel® Graphics Command Center
 (right-click to Pin to taskbar)

Video Driver Controls



Home

Click the Home button to return to the main menu screen in any of the sub-menu screens.

You may make changes to any of the graphics properties by clicking the appropriate icon on the left and you and then adjust the settings from the sub-menus.

Figure C - 26
**Intel® Graphics Command Center
Command Center
(Home Screen)**

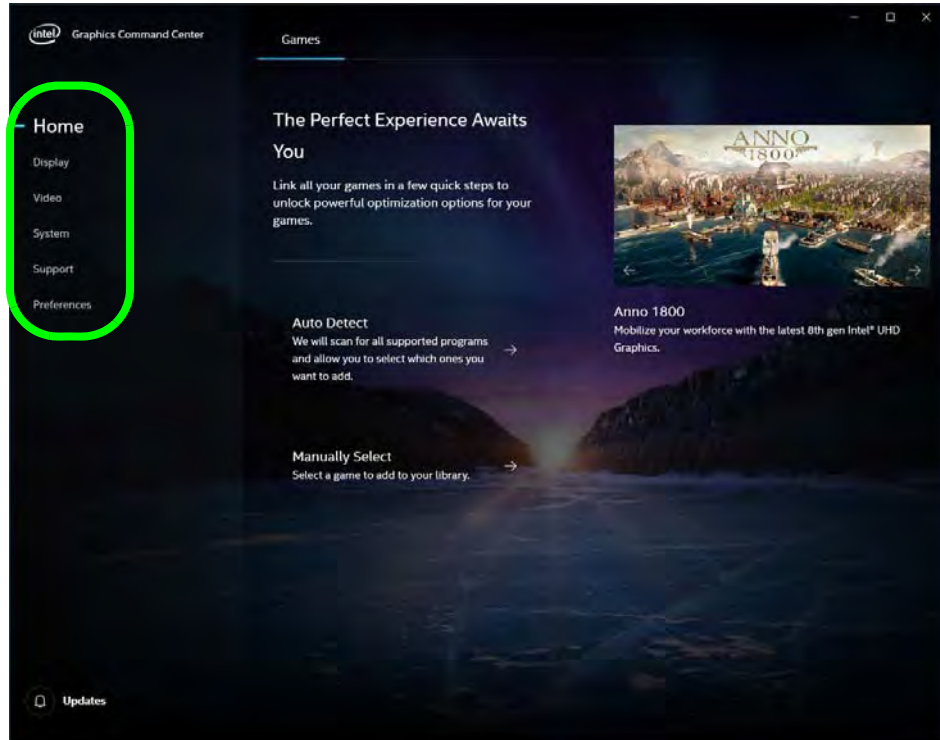

Display

Click either **General** or **Color** to make display adjustments, including configuration for any attached external displays.



Multiple Display

At least one other display must be attached in order to view multiple display selection options.

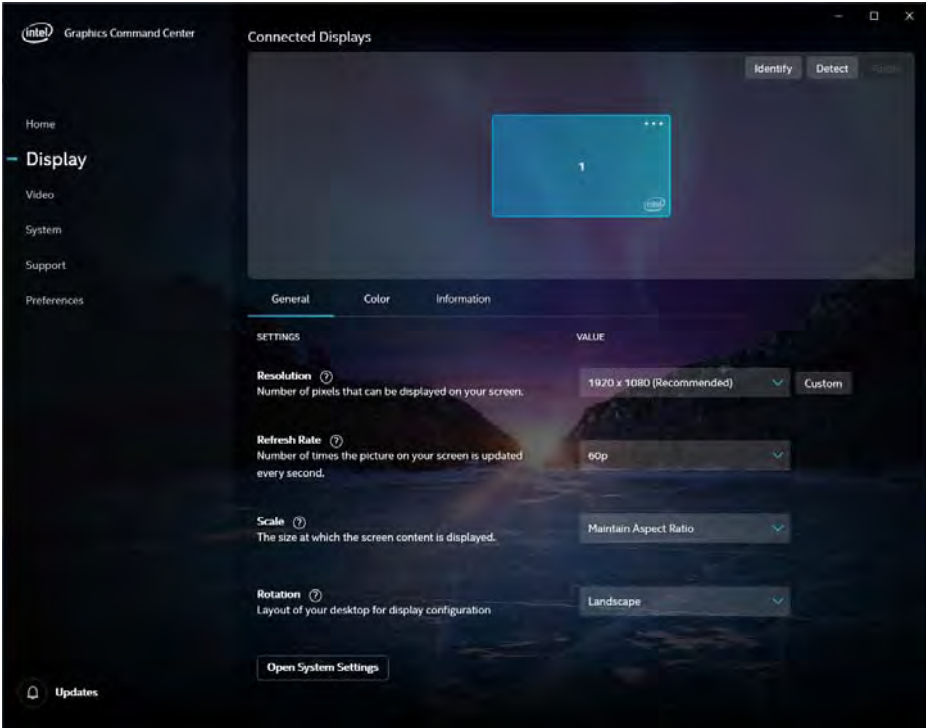
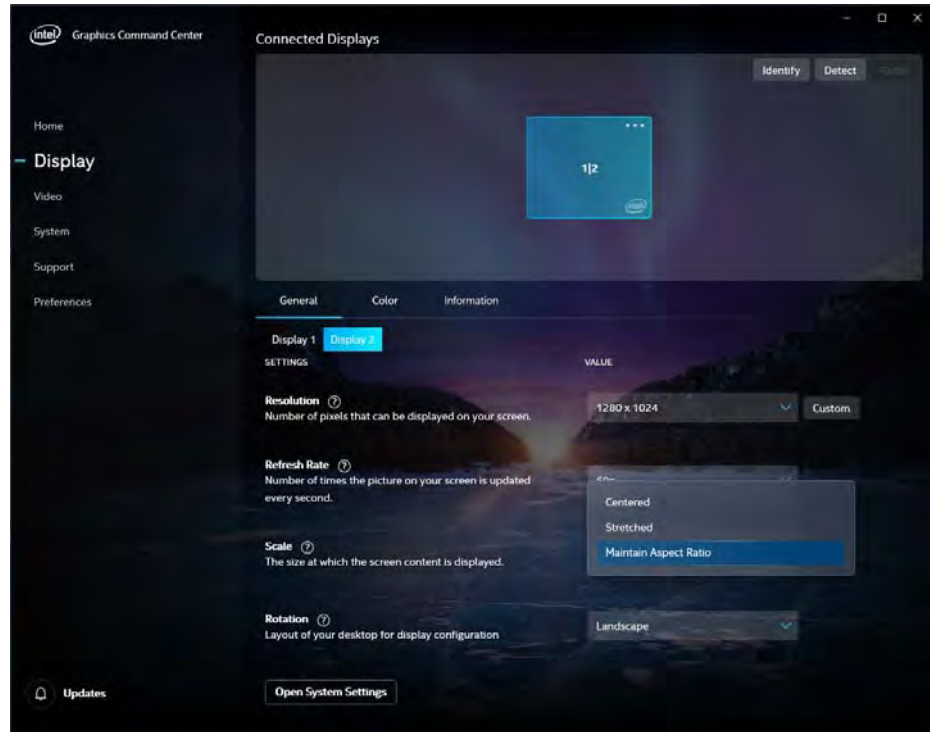

Figure C - 27
Intel® Graphics
Command Center
(Display Screen)

Video Driver Controls

Use the **Display** menu to adjust the display's Resolution, Refresh Rate, Scale, and Rotation, and to access the Display control panel in System Settings.

Figure C - 28
Intel® Graphics Command Center
(Display Scale)



When external displays are attached you can use the **Connected Displays** control panel to configure **multiple displays** (see *“Attaching Other Displays” on page C - 50*). Click on the **dotted lines** at the top right of the display graphic to access the settings options and click **Apply** to save any changes made.

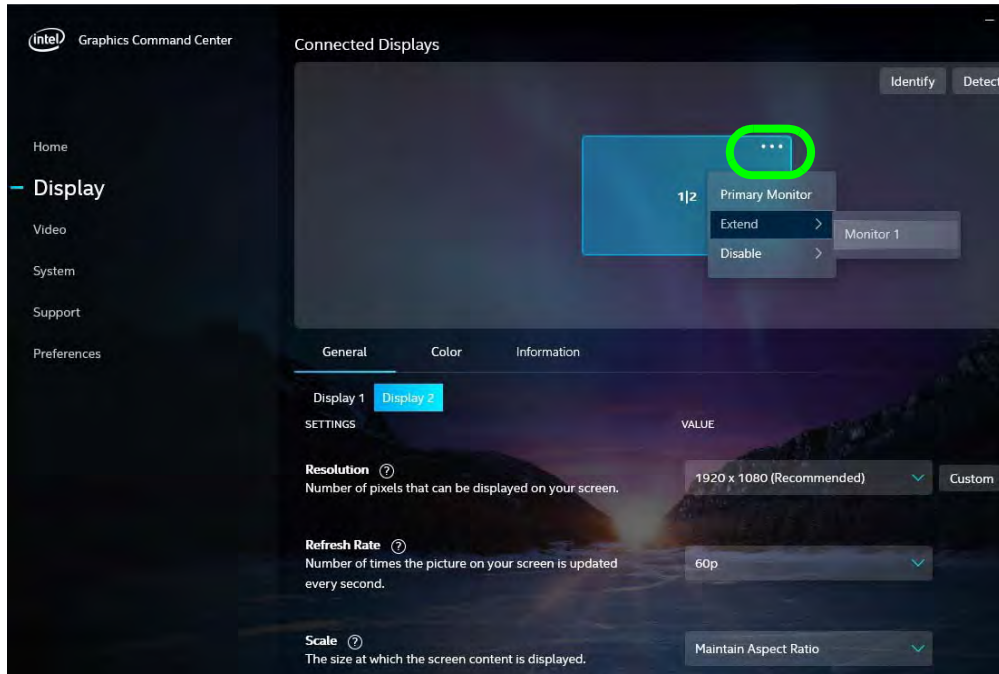

Multiple Display

At least one other display must be attached in order to view multiple display selection options.

Audio Settings

Any attached active displays must have audio capacity to allow audio configuration.

Figure C - 29
Intel® Graphics Command Center Connected Displays

Video Driver Controls

The **Custom Resolutions** sub-menu allows you to adjust the display (or any attached display) to any Timing Standard, Width, Height, Refresh Rate and Underscan percentage of your choice. Note that incorrect settings can cause system instability and even possible component damage, so this is adjusted at your own risk.

Figure C - 30
**Intel® Graphics
Command Center
Custom
Resolutions**

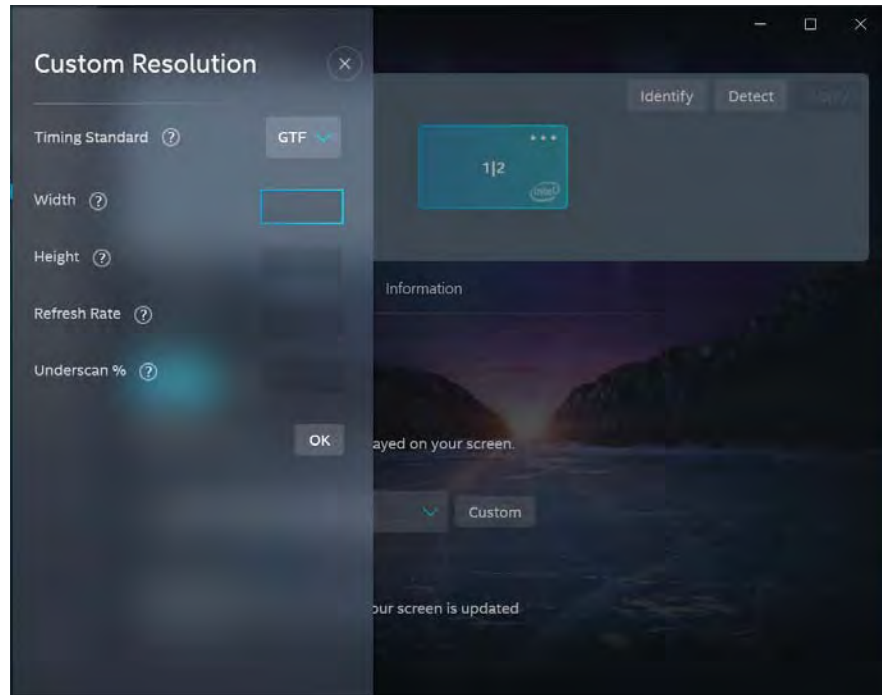

Display (Color)

Use the color sliders from the menu to make changes to the display. If you wish to revert to the default settings simply click on **Restore to Original Colors**.

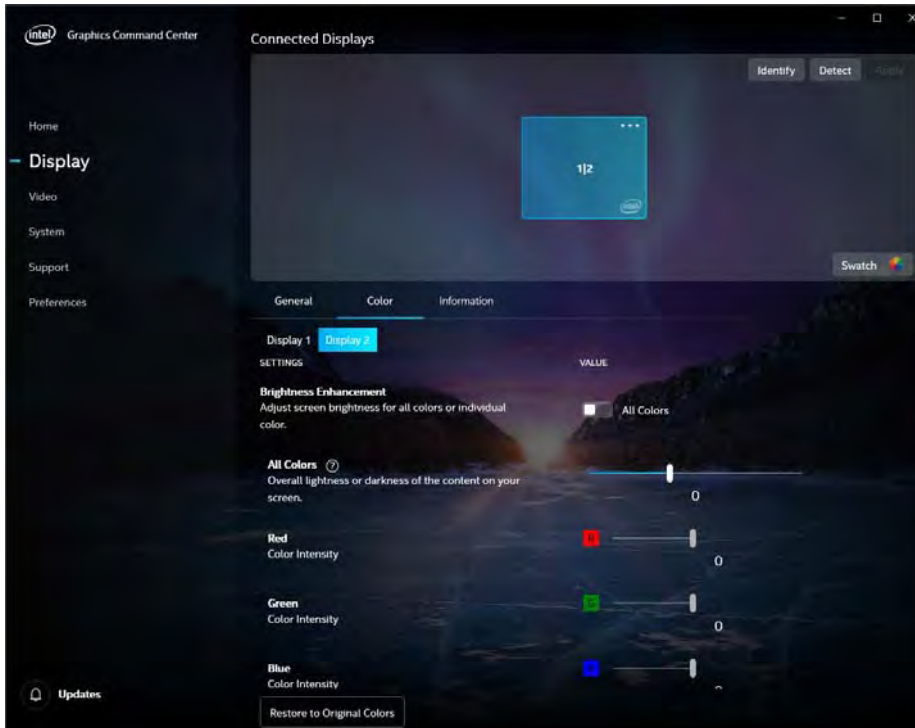

Figure C - 31
**Intel® Graphics
Command Center
(Display - Color
Screen)**

Video Driver Controls

Video

The **Video** menu allows you to brighten or darken movies, adjust colors and a range of other video options. The **Preview** image will display a sample image using the current settings, and you can click **Add Video** to select your own sample video. You will need to click **Custom** to create a **custom profile** to make adjustments to most of the settings and you can rename, duplicate or delete custom profiles.

Figure C - 32
Intel® Graphics
Command Center
(Video)

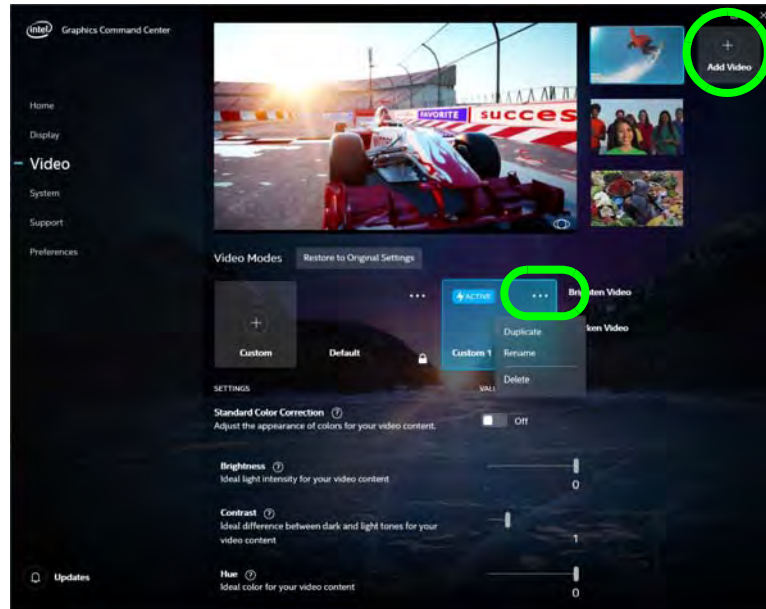

System

Hot Keys in System allows you to create and enable/disable hot keys for opening the application and display rotation etc. Click **Apply** to save changes.

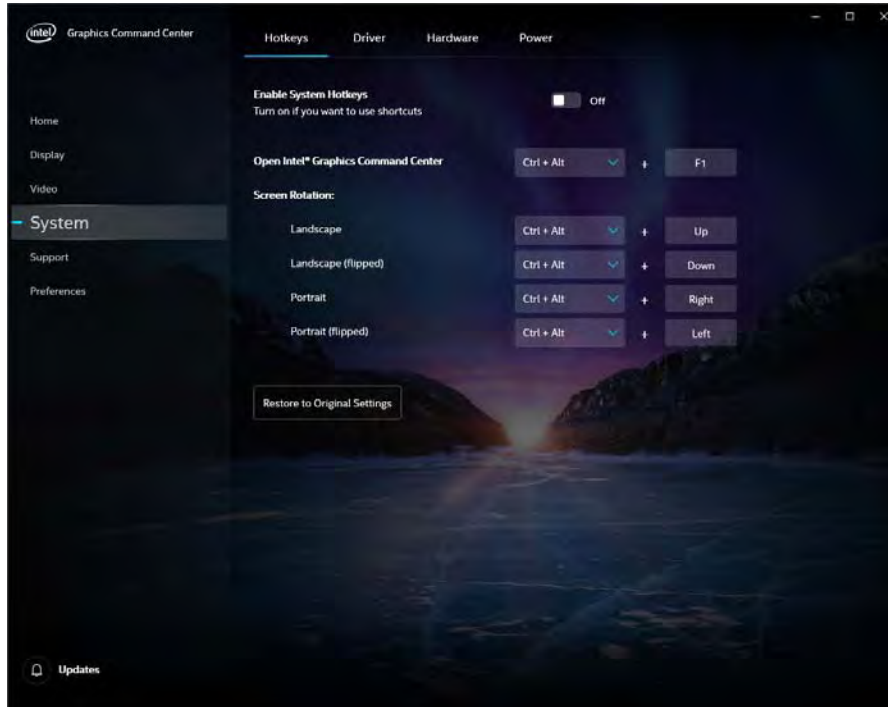
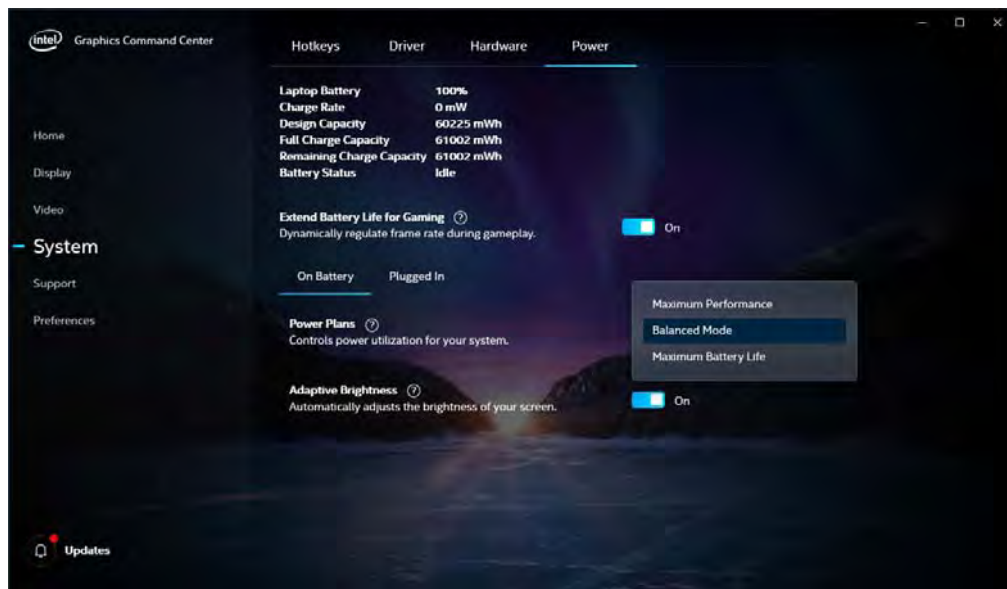

Figure C - 33
Intel® Graphics Command Center (System - Hotkeys)

Video Driver Controls

The **Driver** and **Hardware** tabs provide information on your current video driver version and hardware configuration, and the **Power** tab can be used to extend battery life through dynamic control of the frame rate if **Extended Battery Life for Gaming** is enabled. **Power Plan** can be set to **Maximum Performance**, **Balanced Mode** or **Maximum Battery Life**.

Figure C - 34
Intel® Graphics
Command Center
(System - Power)



Support

Online Resources in **Support** provides links to online support for Intel graphics issues and to the latest drivers. The **System Diagnostic** tab allows you to **Generate Report** on the graphics system (as may be required by online help services).

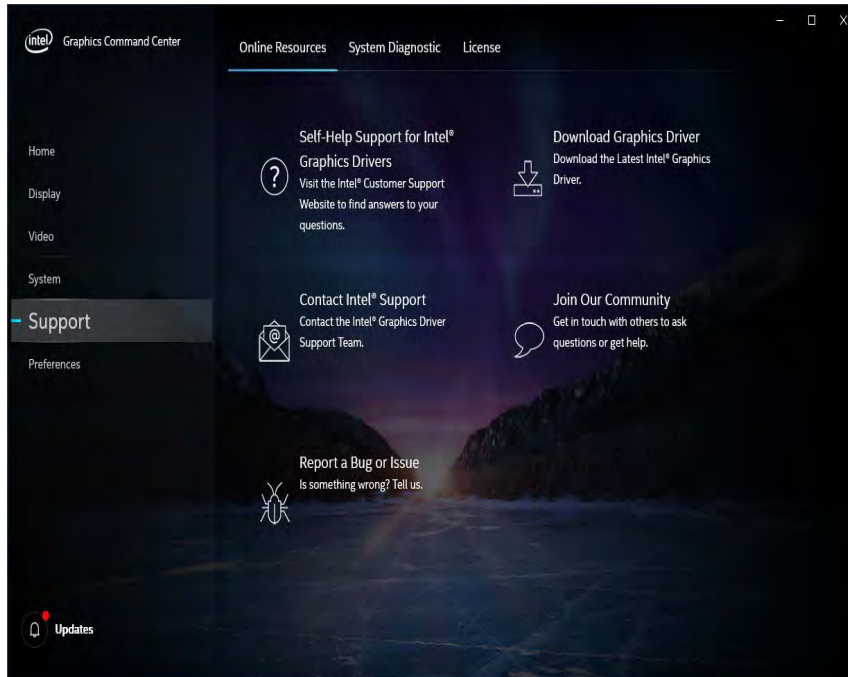

Figure C - 35
**Intel® Graphics
Command Center
(System - Support)**

Preferences

You can configure the app to your preferences from this menu.

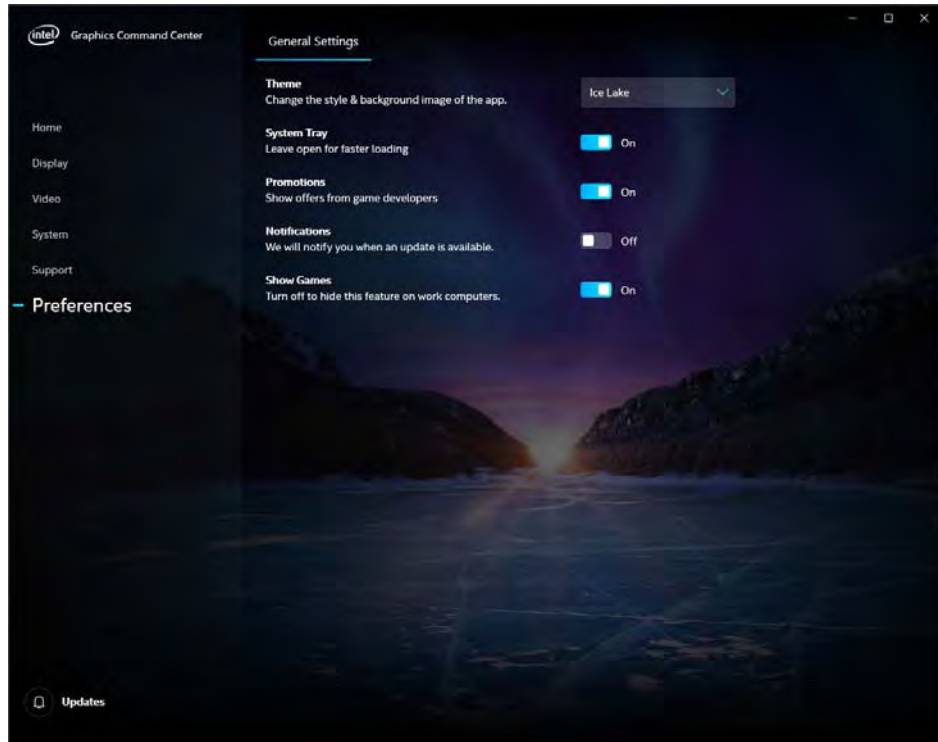

Figure C - 36
**Intel® Graphics
Command Center
(Preferences)**

Intel Graphics Command Center Display Devices

Note that you can use the **Intel Graphics Command Center** to configure external displays connected to the **HDMI port, Mini Display Port or the Thunderbolt 3 port** (an adapter will be required for these ports). See your display device manual to see which formats are supported.

Display Mode	Description
Single Display	One of the connected displays is used as the display device (PC screen only or Second screen only).
Clone/Duplicate	Both connected displays output the same view and may be configured independently
Extended / Extend	Both connected displays are treated as separate devices, and act as a virtual desktop



Attaching Displays

When you first attach an external display you may find that the desktop does not occupy the full screen area. Use either the display's auto adjust/configure controls, or the Intel Graphics Command Center to configure the full screen display.



4K2K Videos on 4K2K External Displays

Note you may experience some video lag when playing 4K2K videos on an attached 4K2K external display.

Table C - 2
Display Modes



Connected Displays

At least one other display must be attached in order to view **Connected Displays** selection options.

Attaching Other Displays

To Mirror Displays:

1. Attach your external display to the appropriate port, and turn it on.
2. Go to the **Intel Graphics Command Center** and click the **Display** menu button.
3. Click **Detect** if you need to scan for any attached displays.
4. The system should automatically be in **Mirror** mode,
5. If not, click on the dotted lines at the top right of the display graphic to access the settings options and select **Mirror** and the Monitor #.
6. Click **Apply** to confirm any settings change if necessary.

Figure C - 37
Display > Mirror

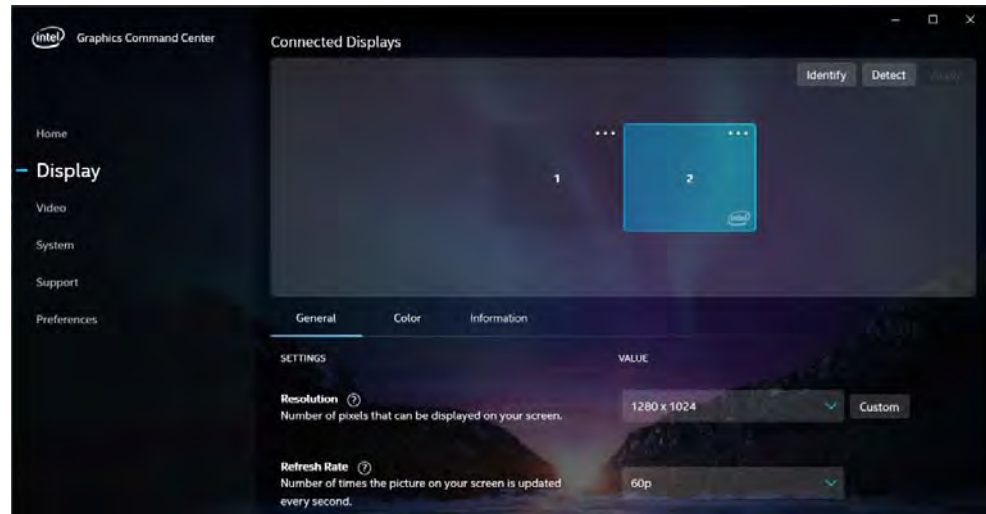

To Enable Extend Mode:

1. Attach your external display to the appropriate port, and turn it on.
2. Go to the **Intel Graphics Command Center** and click the **Display** menu button.
3. Click **Detect** if you need to scan for any attached displays.
4. Click on the dotted lines at the top right of the display graphic to access the settings options and select **Extend** and the Monitor #.
5. Click **Apply** to confirm any settings change if necessary.

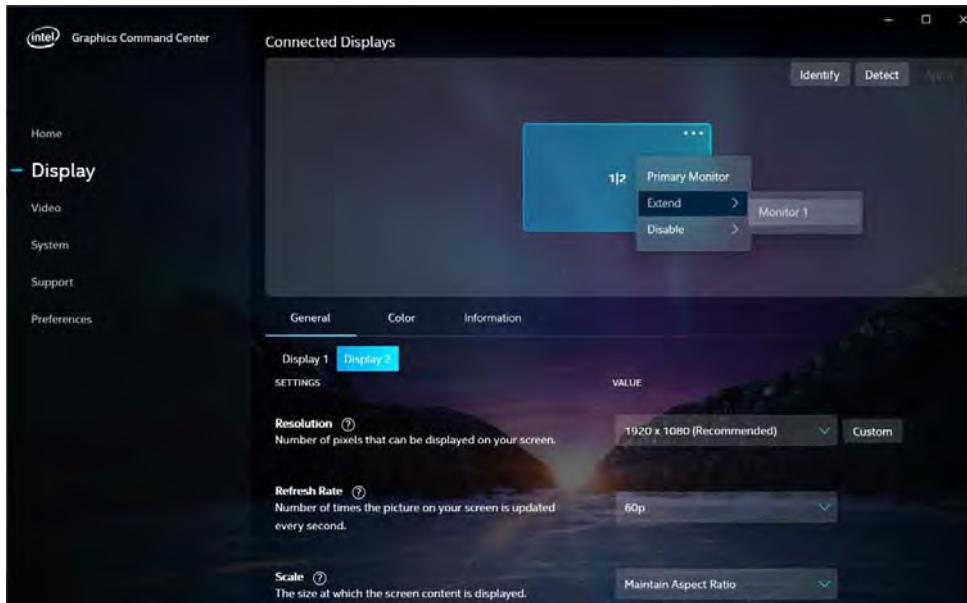

Figure C - 38
Display > Extend

Video Driver Controls

6. You can have different resolutions, monitor refresh rates, scales, rotations and aspect ratios for each display device **provided your display can support them.**
7. You can drag the display icons to match the physical layout of your displays.
8. Icons and programs may also be dragged between the displays.

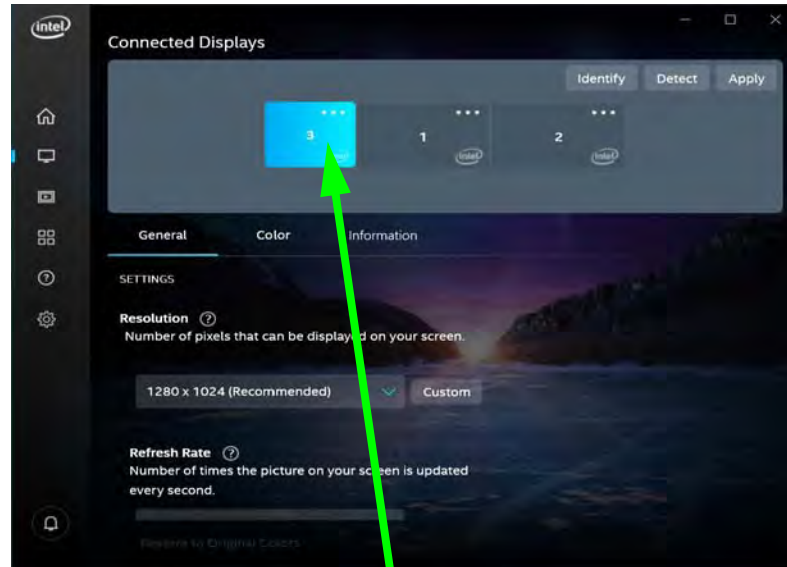

Figure C - 39
Display > Extend
(Drag Display)

Click the appropriate monitor icon and drag it to match the physical arrangement you wish to use (e.g. the secondary display may be extended left/right/above/below the primary display).

Appendix D: Specifications



Latest Specification Information

The specifications listed in this Appendix are correct at the time of going to press. Certain items (particularly processor types/speeds and CD/DVD device types) may be changed, updated or delayed due to the manufacturer's release schedule. Check with your distributor/supplier for details.

Note that this computer model series may support a range of CPUs and/or video adapters.

To find out which **CPU** is installed on your system go to the **Start** menu and select **Settings**, and then select **System** and click **About**. This will also provide information on the amount of **Installed RAM** etc.

To get information on your system's **video adapter** go to the **Start** menu and select **Settings**, and then select **System** and click **Display > Advanced display settings > Display adapter properties**.

Specifications

Core Logic	Memory Expandable from 8GB to 64GB, Compatible with 8GB, 16GB or 32GB Modules	Pointing Device & Keyboard
Mobile Intel® HM470 Express Chipset	 SO-DIMM Memory Types All SO-DIMM memory modules installed in the system should be identical (the same size and brand) in order to prevent unexpected system behavior. Don't mix SO-DIMM memory module sizes and brands in order to prevent system problems.	Built-in Gamma Secure Pad OR Touchpad with Microsoft PTP Multi-Gesture and Scrolling Functionality (Factory Option)
Display		Storage
For Model A Computers: 15.6" / 39.62cm, FHD* (1920 * 1080), 16:9, 3.2mm Thick Backlit Panel 15.6" / 39.62cm, UHD (3840 * 2160), OLED MSHybrid 16:9, 2.2mm Thick Panel	One M.2 2280 SSD with SATA Interface OR Two M.2 2280 SSDs with PCIe Gen 3x4 Interface (RAID 0/1), (Factory Option)	Interface
For Model B Computers: 17.3" / 43.94cm, UHD (3840 * 2160), FHD (1920 * 1080), 16:9, 3.5mm Thick Backlit Panel	Audio	Three USB 3.2 Gen 1 (Type A) Ports (including 1 AC/DC Powered USB Port) One Thunderbolt™ 3 Port =====
Memory	High Definition Audio Interface S/PDIF Digital Output Built-In Array Microphone Two Built-In 2W Speakers Sound Blaster® Atlas	*Note: The maximum amount of current supplied by standard USB Type-C ports is 500 mA for USB2.0/900 mA for USB 3.2. The maximum amount of current supplied by a Thunderbolt 3 port is 3000 mA. =====
Dual Channel DDR4 Two 260 Pins SO-DIMM Sockets Supporting DDR4 up to 3200MHz Memory Modules (<i>real operational frequency depends on the FSB of the processor</i>)		One Mini DisplayPort 1.4 One HDMI-Out (High-Definition Multimedia Interface) Port (with HDCP) One 2-in-1 Audio Jack (Headphone / Microphone)

<p>One 2-in-1 Audio Jack (Microphone / S/PIDF optical output) One RJ-45 LAN Jack One DC-In Jack</p>	<p>Intel® Dual Band Wi-Fi 6 AX200 (2*2 802.11 ax) WLAN + Bluetooth Combo PCIe M.2 2230 Module (Factory Option)</p>	<p>Security</p>
<p>Card Reader</p>	<p>Intel® Dual Band Wi-Fi 6 AX201 (2*2 802.11 ax) WLAN + Bluetooth Combo CNVi M.2 2230 Module (Factory Option)</p>	<p>Security (Kensington® Type) Lock Slot BIOS Password</p>
<p>Micro SD Push-Push Card Reader up to UHS-II</p>	<p>Killer™ Dual Band Wi-Fi AX1650i (2*2 802.11 ax) WLAN + Bluetooth Combo CNVi M.2 2230 Module (Factory Option)</p>	<p>Trusted Platform Module 2.0 (Factory Option)</p>
<p>Slots</p>	<p>Power Management</p>	<p>Intel® PTT for Systems Without TPM</p>
<p>Three M.2 Card Slots: Slot 1: for M.2 2230 WLAN Combo Module Card with PCIe/USB/CNVi Interfaces (E Key) Slot 2 for M.2 2280 SSD (Solid State Drive) Card with SATA / PCIe Gen 3*4 Interface (M Key) Slot 3 for M.2 2280 SSD (Solid State Drive) Card with PCIe Gen 3*4 Interface (M Key)</p>	<p>Supports Wake on LAN Supports Wake on USB (AC Mode Only) Supports Wake on RTC Alarm (AC Mode Only)</p>	<p>For Model A Computers: Finger Print On Glass (Factory Option)</p>
<p>Communication</p>	<p>Power & Battery</p>	<p>For Model B Computers: Area Fingerprint</p>
<p>Built-In 10/100/1000Mb Base-TX Ethernet LAN 1.0M HD PC Video Camera Module</p>	<p>Embedded 3 Cell Polymer Battery Pack 73WH Full Range AC/DC Adapter AC input 100 - 240V, 50 - 60Hz, DC Output 19.5V, 9.23A (180 Watts)</p>	<p>Features (For Some Model Designs)</p>
		<p>Shipping Mode FlexiCharger Virtual Reality Ready Intel® Optane™ Technology (for Intel processor family) Windows® Mixed Reality Compatible These features apply to some individual model designs within this series (check with your distributor/supplier for details)</p>
		<p>Indicators</p>
		<p>LED Indicators - Power/Suspend, Battery, Storage, Camera</p>



Specifications

Operating System	
Windows® 10 19H2 (64-bit)	
BIOS	
One 128Mb SPI Flash ROM Insyde BIOS	
Environmental Spec	
Temperature	
Operating:	5°C - 35°C
Non-Operating:	-20°C - 60°C
Relative Humidity	
Operating:	20% - 80%
Non-Operating:	10% - 90%
Dimensions & Weight	
<u>Model A:</u>	
357.5mm (w) * 238mm (d) * 19.8mm(h), *1.99kg *Barebone System with Battery	
<u>Model B:</u>	
395.9mm (w) * 264.95mm (d) * 19.9mm(h), 2.3kg *Barebone System with Battery	
<i>*A barebone system does not include the HDD, RAM, adapter, power cord and factory option modules (weight tolerance within +/- 5%).</i>	

D

D - 4 Specifications